

+

# NEXT IGNITION

ANNUAL REPORT  
2017



# KEY FIGURES

IN EUR MILLIONS	Year ended Sept 30,		CHANGE	% CHANGE
	2017	2016		
Revenue	910.0	737.5	172.5	23.4%
EBIT	118.4	76.6	41.8	54.6%
Adjusted EBIT	137.6	97.7	39.9	40.8%
Profit for the period	79.2	48.0	31.2	65.0%
Capital expenditure	(45.1)	(53.7)	8.6	(16.0%)
Free cash flow (FCF)	77.8	(238.4)	316.2	<(100.0)%
Adjusted FCF	77.8	57.3	20.5	35.8%
EBIT as % of revenue	13.0%	10.4%		
Adjusted EBIT as % of revenue	15.1%	13.2%		
Profit in % of revenue	8.7%	6.5%		
Capital expenditure as % of revenue	5.0%	7.3%		
FCF in % of revenue	8.5%	(32.3%)		
Adjusted FCF in % of revenue	8.5%	7.8%		
Net leverage ratio	1.5x	2.5x		

**REVENUE BY REGION**  
(LOCATION OF STABILUS COMPANY)

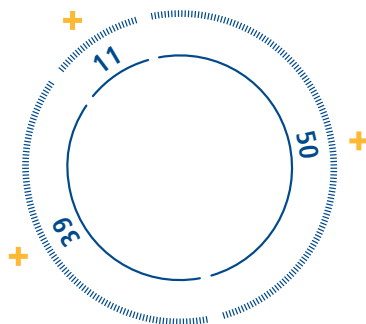

50% — Europe  
39% — NAFTA  
11% — Asia / Pacific and RoW

**REVENUE BY MARKETS**

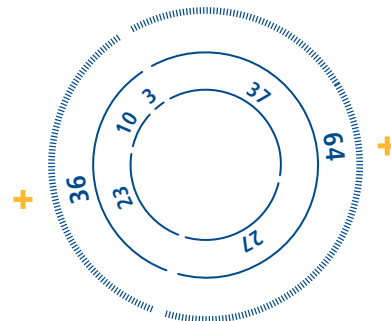

64% — Automotive Business  
37% — Automotive Gas Spring  
27% — Automotive Powerise

36% — Industrial Business  
23% — Industrial / Capital Goods  
10% — Vibration & Velocity Control  
3% — Commercial Furniture



# NEXT LEVEL **MOTION CONTROL**



As one of the world's leading providers of gas springs, dampers and electromechanical drivers, we have been showing our prowess for eight decades – in the automobile industry, mechanical engineering, shipping, aviation, renewable energies and a host of other sectors such as the furniture segment and building services engineering. With our gas springs, dampers and electromechanical Powerise drives, we optimize opening, closing, lifting, lowering and adjusting actions from deep sea to outer space.

# OUR UNITS

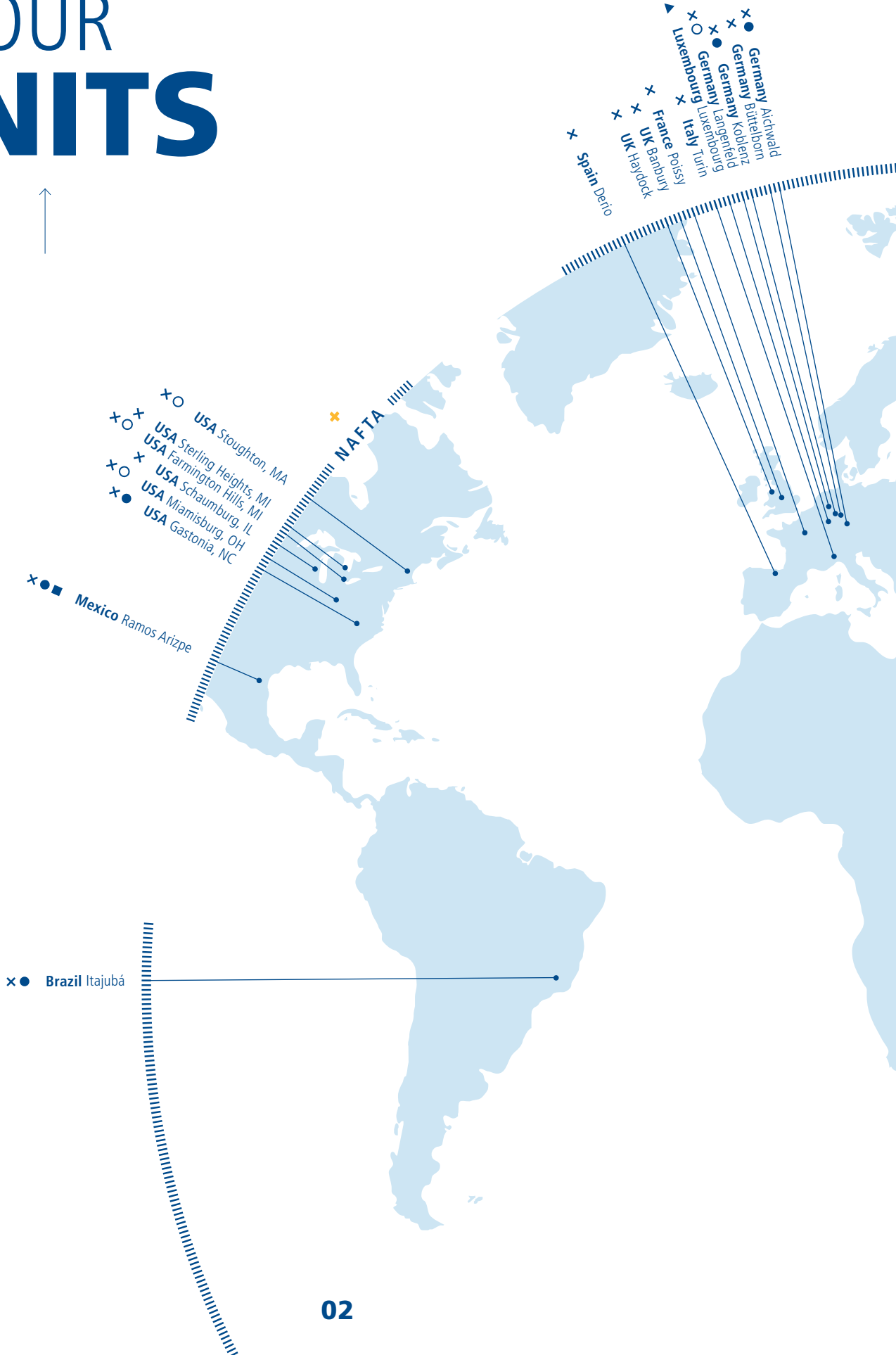





- Production Powerise
- Production Gas Springs
- Production Vibration & Velocity Control
- × Sales office / Representation
- ▲ Stabilus S.A.

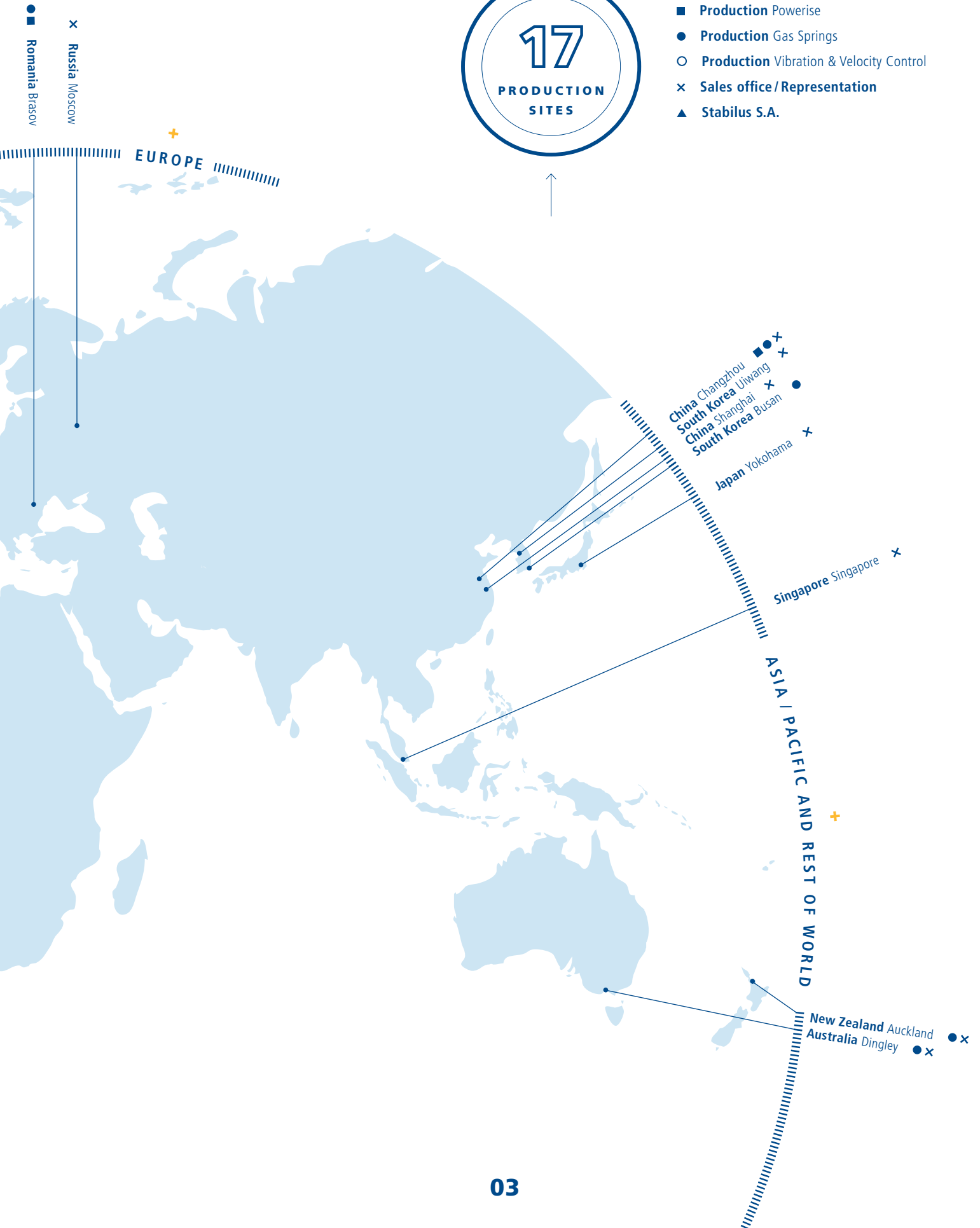



# CONTENTS

## A

### TO OUR SHAREHOLDERS

- 06 Letter from the Chief Executive Officer
- 08 Report of the Supervisory Board
- 10 International Management Team
- 12 Next Level Motion Control
- 32 Stabilus Share

## B

### COMBINED MANAGEMENT REPORT

- 37 General
- 37 Strategy
- 39 Business and General Environment
- 41 Results of Operations
- 45 Development of Operating Segments
- 46 Financial Position
- 48 Liquidity
- 51 Statutory Results of Operations and Financial Position of Stabilus S.A.
- 51 Risks and Opportunities
- 57 Corporate Governance
- 60 Subsequent Events
- 60 Outlook

## C

### CONSOLIDATED FINANCIAL STATEMENTS

- 63 Consolidated Statement of Comprehensive Income
- 64 Consolidated Statement of Financial Position
- 66 Consolidated Statement of Changes in Equity
- 67 Consolidated Statement of Cash Flows
- 68 Notes to the Consolidated Financial Statements
- 130 Responsibility Statement
- 131 Management Board of Stabilus S.A.
- 132 Supervisory Board of Stabilus S.A.
- 133 Independent Auditor's Report

## D

### ANNUAL ACCOUNTS

- 140 Balance Sheet
- 142 Profit and Loss Account
- 143 Notes to the Annual Accounts
- 151 Independent Auditor's Report

## E

### ADDITIONAL INFORMATION

- 158 Financial Calendar
- 158 Disclaimer
- 159 Table Directory
- 161 Information Resources



# TO OUR **SHARE HOLDERS**

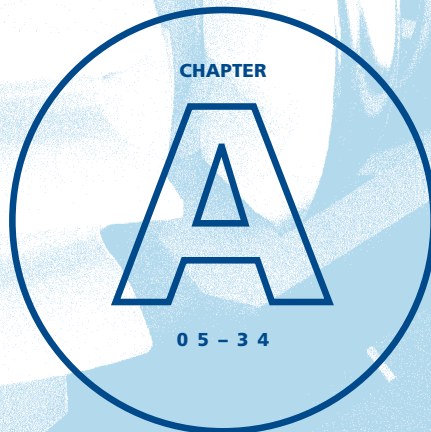

# LETTER FROM THE CHIEF EXECUTIVE OFFICER



+ DIETMAR SIEMSEN

**Dear Shareholders, Customers,  
Business Partners, Employees,  
Ladies and Gentlemen,**

We can look back on a new record-breaking fiscal year in which we increased our revenue by more than 23% to around €910 million. In all regions, we posted strong and profitable growth, both organically and with our purchases made in 2016. With the successful integration of ACE, Hahn Gasfedern, Fabreeka and Tech Products, we have shown that we can grow both organically and through significant value-enhancing acquisitions.

2017 was another successful fiscal year for us, and it saw early attainment of most of the targets for the 2020 fiscal year that were set in 2011 in our long-term plan STAR 2020. These include breaking the €800 million revenue barrier as well as establishing a balanced international positioning and a well-stocked innovation pipeline.

Against this background, we have updated our targets and entrenched them in our STAR 2025 strategy, which we will be explaining in further detail in this annual report. Our vision is to become the world's leading company for motion-control solutions by 2025.

Maintaining profitable growth is a key target here. Accordingly, we are aiming for average annual revenue growth of at least 6% up to 2025. We firmly believe in the strong market potential of our products. Consequently, we expect to at least double the consolidated revenue of €737.5 million generated in the 2016 fiscal year in the long term. We therefore remain ambitious in our pursuit of growth.

With the three global megatrends of demographic change, higher standards of living and greater demand for convenience as well as rising health and safety requirements, the fundamental growth drivers for Stabilus remain intact in the long term. In addition, increasing digitalization – which often goes hand in hand with growing automation of motion sequences – and autonomous driving present us with major opportunities.





» Our vision is to become the world's leading company for motion-control solutions by 2025. «

Global demand for our products remains high: We made substantial gains in all three regions (Europe +25.3%, NAFTA +21.3% and Asia/Pacific and RoW +22.2%). In terms of income, we increased adjusted EBIT by around 40.8% to €137.6 million in the 2017 fiscal year, while net income rose from €48 million in the 2016 fiscal year to €79.2 million in the 2017 fiscal year. We want our shareholders to participate in this positive development and will propose a dividend of €0.80 per share to the forthcoming Annual General Meeting, after €0.50 in the previous year.

Investment in our growth will remain the backbone of our success in the future. In the 2017 fiscal year, our investment (CAPEX) totaled more than €45 million. Among other investment activities, we purchased land in Romania for future expansion of our Powerise production there, extended the capacity of our gas-spring and Powerise production in various countries, and capitalized research and development costs of more than €11 million, as major R&D projects were concluded. In addition, we significantly increased R&D expenses from 3.6% of sales in fiscal year 2016 to 4.2% in fiscal year 2017. Digitalization provides us with a host of opportunities to continue our success story by developing future-oriented, innovative and, increasingly, intelligent solutions.

For the 2018 financial year, we are expecting organic revenue growth of approx. 7 percent to EUR 975 million – assuming a, compared to the previous FY, constant average USD/EUR exchange rate in FY2018 of 1.10 \$ / €. We would expect revenues of some EUR 960 million assuming the

current average USD/EUR exchange rate of 1.15 \$/€. It is anticipated that the adjusted EBIT margin will stand at around 15.5 percent.

I would like to take this opportunity to thank our shareholders for the confidence they have shown in Stabilus. On behalf of the entire management team, I also thank our employees for their consistently hard work and their team spirit, which they have demonstrated in the integration of the purchased companies. Last but by no means least, many thanks are also due to our customers for their loyalty and commitment to quality, and to our business partners for the strong partnership we enjoy, which dates back many years in some cases.

We look forward to continuing on our growth path with you in the 2018 fiscal year.

Yours sincerely,

**Dietmar Siemssen**  
C E O

Our planning up to 2025 has four focal points: Gaining new customers for current products, even better penetration of existing markets, tapping into new markets and regions, and product innovations. Innovative applications in the industrial sector will make our company's position as a supplier to many branches of industry even stronger. Stabilus' conventional business with gas springs and dampers will be just as crucial here as the marketing of existing Powerise® solutions and a new electromechanical one.

With regard to the 2017 fiscal year, our automobile and industrial operations recorded revenue growth: Revenue in the automobile business rose by 13.3% to €583.7 million, while the industrial business posted growth of 46.8% to €326.3 million.

The ongoing trend towards SUVs and Powerise® sales were again major growth drivers in the automobile segment. Along with strong organic growth in the industrial segment, the companies acquired in June 2016 particularly contributed to the growth in revenue compared with the previous year.

# REPORT OF THE SUPERVISORY BOARD



+ UDO STARK

## Dear Shareholders,

During the reporting period from October 1, 2016 to September 30, 2017, the Supervisory Board of Stabilus S.A. performed its tasks and monitored the activities of the Management Board in accordance with legal requirements and the Articles of Association of Stabilus S.A. The Management Board and the Supervisory Board maintained close and regular contacts. The Supervisory Board advised the Management Board in regard to strategic and operational decisions as well as governance topics and decided on matters requiring supervisory approval.

## Cooperation with the Management Board

The Management Board reported regularly, promptly and extensively in verbal and written form to the Supervisory Board regarding the current status and performance of the Company and the Stabilus Group, including its commercial position as well as its relevant financial data. Furthermore, the Management Board informed the Supervisory Board on a regular basis concerning the future business policy, including the strategic and organizational direction of the Group.

The Supervisory Board held in total seven meetings during the last fiscal year and so far three in the current fiscal year. In all meetings, all of the Supervisory Board members were present.

The Supervisory Board was involved in the main projects of Stabilus. In particular, the Management Board informed about the integration of the recently acquired entities ACE, Hahn, Fabreeca and Tech Products. Based on a smooth integration process, the new Stabilus companies are meanwhile significantly contributing to Stabilus' corporate development and economic results. Furthermore, the Management Board informed the Supervisory Board in regard of growth activities and opportunities – both, organic growth and potential M&A opportunities.

The Management Board further discussed in detail with the Supervisory Board developments for new products / markets – like powered vehicle doors or power units for height-adjustable tables. Stabilus expects that these applications will have a potential for fast growth in future years.

A further subject of discussion and decision was the simplification of the legal structure of the Stabilus Group which was undertaken in the course of last fiscal year. In total, five sub-holding companies which were established in Stabilus' private equity history have now been eliminated

by way of merger into other Stabilus entities. Thereby, the complexity of the Stabilus Group has been reduced significantly. The Management Board provided regular reports about Stabilus' business performance in the various geographic markets (operating segments). Major investments of the Group companies, in particular investments for capacity extensions in key markets and a new software system supporting Stabilus' quality processes were presented to and approved by the Supervisory Board. The Management Board reported also about cost and quality matters as well as other operational topics related to Stabilus' products.

#### **Audit Committee and Remuneration Committee**

Material questions concerning auditing, accounting, risk management and compliance and respective controls and systems have been treated within the Audit Committee. The Audit Committee discussed in particular the Quarterly Reports, the relationship with investors, the internal audit program 2017/18 and the audit assignment to KPMG Luxembourg Société Coopérative including the focus areas of their audit. During the reporting period, the Audit Committee held

five meetings and two meetings since the beginning of the current fiscal year. In all meetings, all of the Audit Committee members were present.

Remuneration and general Board matters were discussed by the Remuneration Committee. During the reporting period, the Remuneration Committee held four meetings and one meeting since the beginning of the current fiscal year. In all meetings, all of the Remuneration Committee members were present.

#### **Drawing up of the Financial Statements**

The Supervisory Board examined the Company's stand-alone annual accounts, the consolidated financial statements and the management report for the fiscal year ending on September 30, 2017. Representatives of the auditor KPMG Luxembourg Société Coopérative attended the meetings of the Audit Committee on November 22, 2017 and on December 13, 2017 at which the financial statements were examined. The representatives of the auditor reported extensively on their findings, provided a written presentation and were available to give additional explanations and opinions.

The Supervisory Board did not raise objections to the Company's annual accounts or to the consolidated financial statements drawn up by the Management Board for the fiscal year ending on September 30, 2017 and to the auditors' presentation. According to the recommendation of the Audit Committee, the Supervisory Board agreed to the proposal of the Management Board

+

» Based on a smooth integration process, the new Stabilus companies are significantly contributing to Stabilus' corporate development and economic results. «

to approve both the Company's annual accounts and the consolidated financial statements for fiscal year 2017. The auditor issued unqualified audit opinions on December 13, 2017.

On behalf of the Supervisory Board, I would like to thank the Stabilus Management for excellent achievements throughout the last fiscal year and for the open and effective collaboration. I want to thank the Stabilus employees for their remarkable contributions to the Company's success as well as our shareholders for the highly valued trust which they place in Stabilus.

Luxembourg, December 13, 2017

On behalf of the Supervisory Board of Stabilus S.A.



**Udo Stark**  
CHAIRMAN OF THE  
SUPERVISORY BOARD



# INTERNATIONAL MANAGEMENT TEAM



01  
+

02  
+

03  
+

04  
+

05  
+

06  
+

07  
+

01  
**Pink, Johannes**  
Vice President  
Global Operations

02  
**Tian, Xuefeng (Alex)**  
Country Head  
China

03  
**Kadenbach, Ekkehard**  
Vice President  
Global Purchasing

04  
**Lee, Joong-Ho (James)**  
Country Head  
Korea

05  
**Roland, Jürgen**  
Vice President Business Unit  
Vibration & Velocity Control

06  
**Balmert, Joachim**  
Vice President  
Quality Management

07  
**Sander, Karsten**  
Vice President  
Business Unit Automotive

08  
**Wilhelms, Mark**  
Chief Financial Officer

09  
**Widmer, Martina**  
Vice President  
Global HR

10  
**Siemssen, Dietmar**  
Chief Executive Officer

11  
**Häring, Fred**  
Vice President  
Business Unit Swivel Chair

12  
**Huber, Ralph**  
Vice President  
Business Unit Industrial

13  
**Sabet, David**  
Vice President  
Business Unit Powerise

14  
**Haba, Anthony**  
Regional Head  
NAFTA

15  
**Hinck, Michael**  
Country Head  
Japan



08  
+

09  
+

10  
+

11  
+

12  
+

13  
+

14  
+

15  
+





NEXT  
LEVEL  
**MOTION  
CONTROL**

Stabilus is at the forefront of developing new ways to control motion. Gas springs, dampers, electromechanical drives and other solutions from Stabilus optimize opening, closing, lifting, lowering as well as adjusting actions and protect against vibration in a large variety of industries. Having started out as a single component supplier, Stabilus today provides complete systems that improve the way many millions of people interact with everyday objects.





»We implemented the STAR process to unleash the full potential of the company and implement our learnings from the 2008/2009 economic crisis.«

**Mark Wilhelms**  
C F O

Since Stabilus gas springs went into series production in 1962, more than three billion devices have been produced. Laid out end to end, they would stretch roughly three times the distance from Earth to the Moon. This success has been possible because over the decades, Stabilus has consistently taken changed and enhanced user requirements into account with new potential applications for its products. For instance, the importance of adjustable height of office chairs to workplace ergonomics and employee health was still unrecognized in 1962. These days, all office chairs have continuous height adjustment – mostly with the use of a gas spring. In modern automobile engineering, new uses for gas springs and dampers regularly enable extra comfort and safety features. For example, bonnet dampers make opening and closing easier. At the same time, the bonnet is more in tune with the overall design, and the vehicle design looks more dynamic and elegant. In addition, seats and seating groups can be moved more easily and safely, for example in order to enlarge the vehicle’s load compartment.

**Powerise® – A Success Story**

The Powerise® electromechanical spindle drive has generated huge growth momentum for Stabilus in recent years. It now sets benchmarks in the automobile industry as a drive for vehicle tailgates, and is used in most vehicle types.

While market penetration in the automobile industry has increased, Stabilus Powerise® drives are now also being more widely used in areas outside the automobile sector.

**Clear Milestones on the Road to Success**

When the economic climate was dramatically altered following the financial and economic crisis 2008/2009, Stabilus responded to these changes by developing the STAR strategy process. STAR stands for **Stabilus Reloaded**, to fully capture all the strategic improvements we are implementing. It sets our vision for 2020 by defining our targets for 2020. Based on this, individual targets and projects were derived for all regions and functions as well as for sales and application development. Each department devised the key aspects with which it does it utmost to ensure attainment of the company’s targets.

Along with profitable growth, the targets of STAR 2020 focused on internal processes and improvements in quality. Through rigorous implementation of the STAR process in all segments and at all levels, the vision and the long-term targets were quickly communicated to the entire Stabilus workforce. Employees were enthused by the notion of growth. With great flair and creative ideas, in the years since 2011, they have been instrumental in a more than twofold increase in revenue from €412 million to €910 million between 2011 and 2017.

**Targeted Expansion of the Product Range**

With the acquisition of ACE, Hahn Gasfedern, Fabreeka and Tech Products in summer 2016, Stabilus substantially broadened its product range. At the same time, the foundations were laid for developing an even more diverse array of motion-control solutions in the future.

By rigorously implementing STAR 2020 throughout the company, Stabilus managed to attain the relevant targets set for the 2020 fiscal year at the start of the STAR process as early as the 2017 fiscal year. These include breaking the €800 million revenue barrier as well as establishing a balanced international positioning and a well-stocked innovation pipeline.

Against this background, Stabilus recently updated the targets set in STAR 2020 and launched the STAR 2025 strategy process. Now, the company’s vision is to become the world’s leading company for motion-control solutions by 2025.



# THE NEXT STEP **STAR 2025**



Long-term planning and the setting of ambitious targets have proved their worth for Stabilus. Five targets form the key pillars of further company development.

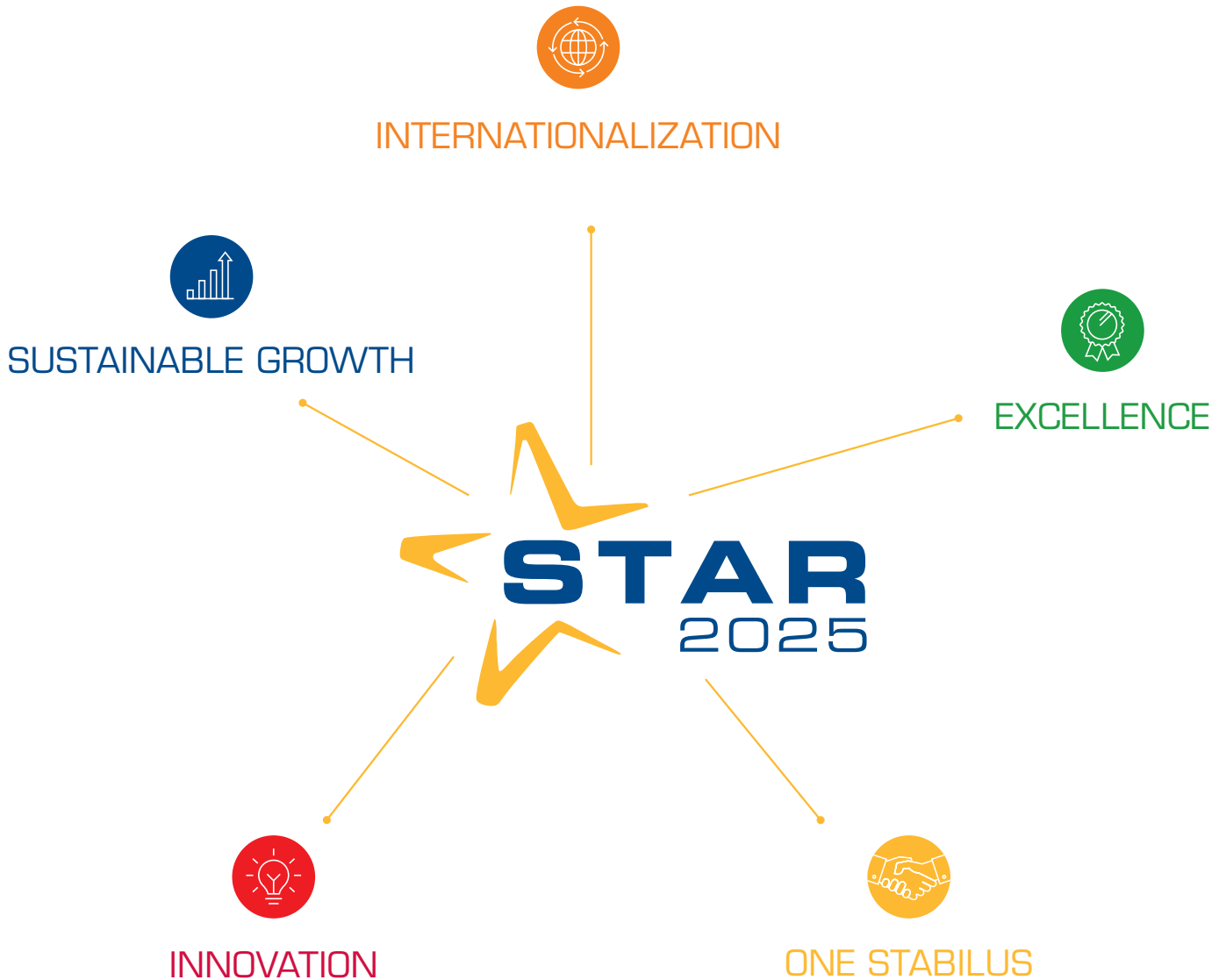

### Sustainable Growth

Stabilus aims to keep on outperforming the market, and has set an annual revenue growth target averaging at least 6%. This is to be attained by gaining new customers, introducing product innovations and tapping into new and existing markets. The company is also keen to carry on exploring selected external growth opportunities. These growth ambitions are driven by global developments and megatrends.

### Globalization

Stabilus intends to further expand its global presence in a targeted way and is committed to growth in the respective markets. In doing so, Stabilus is living out its “in the region for the region” approach, under which regional development and sales expertise is built up locally in the target markets. Orders from a region are to be produced largely in that same region in the medium to long term.

### Excellence

Stabilus’ excellence initiative involves more than just excellence in terms of production and product quality. The initiative aims at ensuring that all employees continuously pursue excellence in all of their actions. Every single process and operation inside the company, from recruitment through to customer contact, is to be steadily and progressively improved. In short, our guiding principle is excellence in everything we do.

### Innovation

Bringing innovations to market maturity and setting market standards have long been strengths of Stabilus. To cement its leading position, the com-

pany is investing in a growing number of development projects. These are all aimed at shortening innovation cycles, establishing a culture of innovation in the company and continuously filling the innovation pipeline with new products and applications. The company derives its growth potential from global megatrends.

### One Stabilus

Lasting corporate success is built on the targeted performance of all employees. A corporate culture that promotes innovations and change is another success factor. In addition to further organizational and structural integration, this also requires a Group-wide team spirit and togetherness, which Stabilus fosters with corresponding values and managerial guidelines. With these measures, Stabilus aims to ensure that employees identify strongly with the company’s targets

STAR 2025

# SUSTAINABLE GROWTH

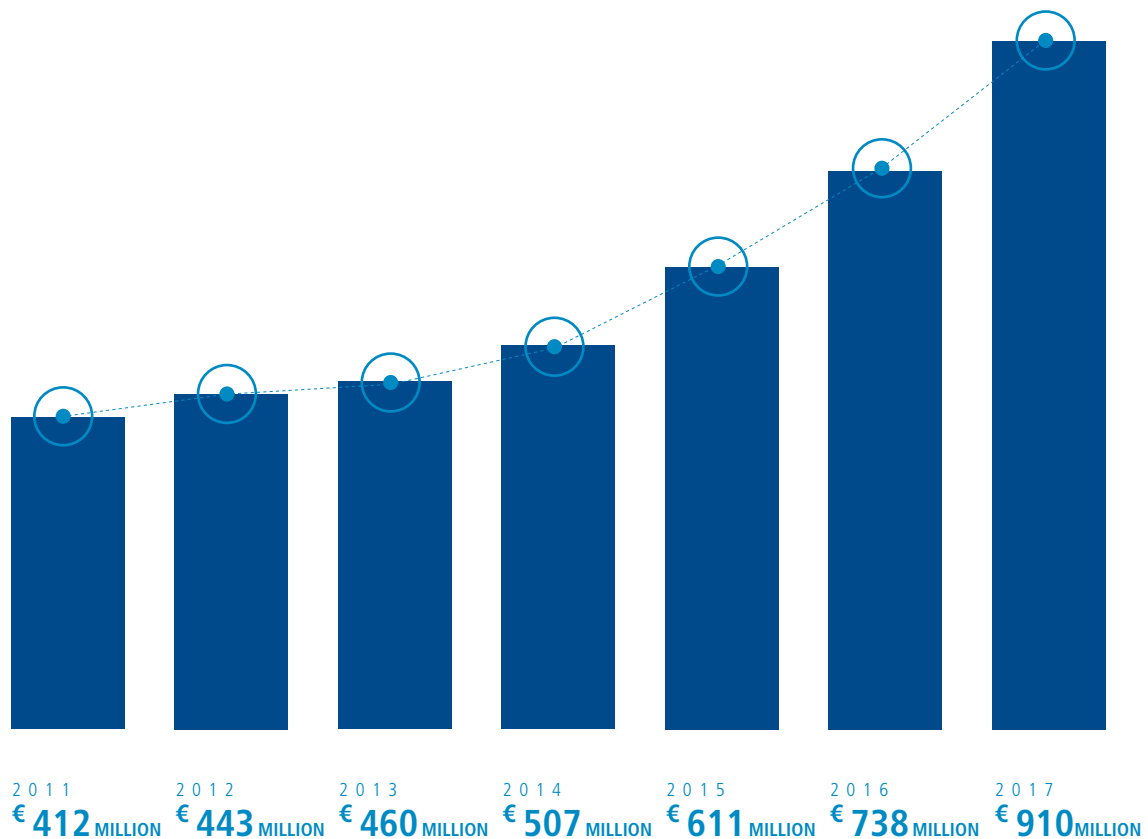

The foundations for Stabilus' growth were laid with STAR 2020. With STAR 2025, Stabilus is now set to remain on its ambitious and profitable growth path in the future.



PRODUCED GAS SPRINGS

**3,000,000,000** SINCE 1962

PRODUCED POWERISE

**13,000,000** SINCE 2011

SALES GROWTH SINCE 2011

**€ 498,000,000** +121%



+

» We have more than doubled our revenues since 2011 – long term, we see potential to remain on this ambitious and profitable growth path. «

**Dietmar Siemssen**  
CEO



Maintaining profitable growth remains a key target for Stabilus. Accordingly, the company is aiming for average annual revenue growth of at least 6% up to 2025. On account of the strong market potential for Stabilus products, the Management Board also expects to be able to at least double the consolidated revenue of €737.5 million generated in 2016 in the long term. Therefore, the company remains ambitious in its pursuit of growth. As well as gaining new customers for current products and even better penetration of existing markets, product innovations and tapping into new and existing markets are also key success factors. To this end, Stabilus is continuously expanding its range of rel-

evant products and systems. The application engineers in the five business segments and the central Research and Development department work closely together to achieve this.

With the three global megatrends of demographic change, higher standards of living and greater demand for convenience as well as rising health and safety requirements, the fundamental growth drivers for Stabilus remain intact in the

long term. Innovative applications in the industrial sector will make the company's role as a supplier to many branches of industry even stronger. Stabilus' conventional business with gas springs and dampers will be just as crucial here as the marketing of existing Powerise® solutions.

In 2017 we re-defined the scope of our Business Development department to provide more focus on the early identification of M&A and market opportunities. The systematic monitoring and analysis of relevant targets will provide extra long-term growth potential for Stabilus.

STAR 2025

# GLOBALIZATION

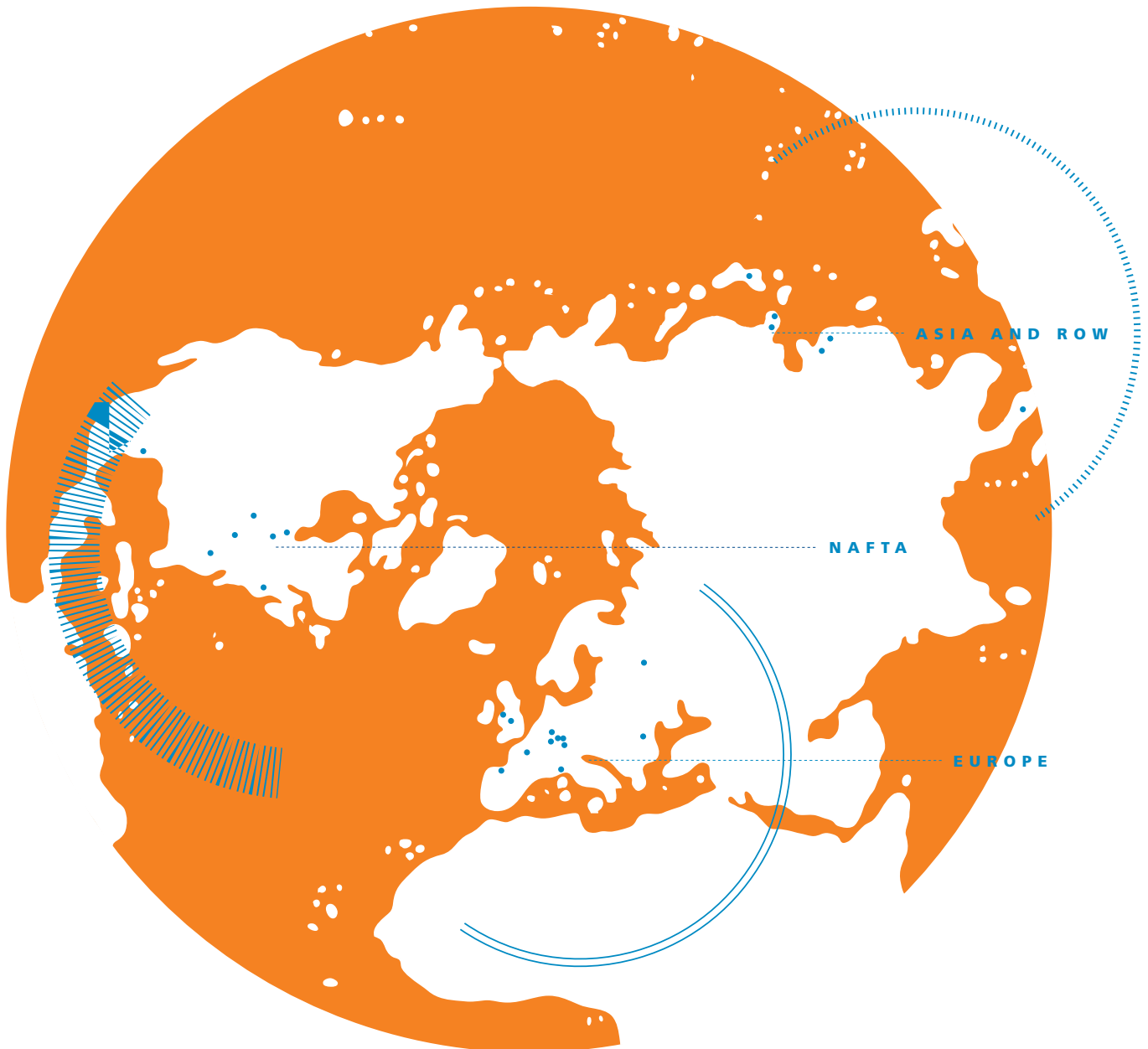

With 17 production locations around the world,  
Stabilus is close to its customers.



» Fast responses and an understanding of the market and consumers matter to our customers. «

**Xuefeng Tian**  
COUNTRY HEAD CHINA



» It is imperative that we have a global presence combined with regional strength – just like our customers. «

**Joong-Ho Lee**  
COUNTRY HEAD KOREA



» With our ability to identify global trends, we are in a position to advise our clients and jointly create innovative products. «

**Michael Hinck**  
COUNTRY HEAD JAPAN



Stabilus will continue to heed its guiding principle “in the region for the region” in its future growth. Orders from a region are to be fulfilled largely in that same region. Regional expertise and local application engineers who can respond to customer requirements immediately are essential to this. For instance, the desired kinematics of modules and optimization of gas springs, dampers and electro-mechanical drives in line with requirements are developed in conjunction with customers. At the

end of the process, there is a solution that enables controlled motion of product parts such as lids, doors and system components or even the complete product, e.g. a driving simulator, and means greater comfort and safety for end users.

All over the world, product cycles are getting ever shorter in many industries, while the number of model variants is rising. Manufacturers are thus responding to their customers’ increasingly diverse requirements. Against this background, with its balanced regional presence, Stabilus aims to be engaged by customers as a development partner at an early stage so that the company can provide the best possible advice and service. With its approach of strengthening the regions, Stabilus is ideally placed to benefit from the global trend towards product differentiation.

STAR 2025

# EXCELLENCE

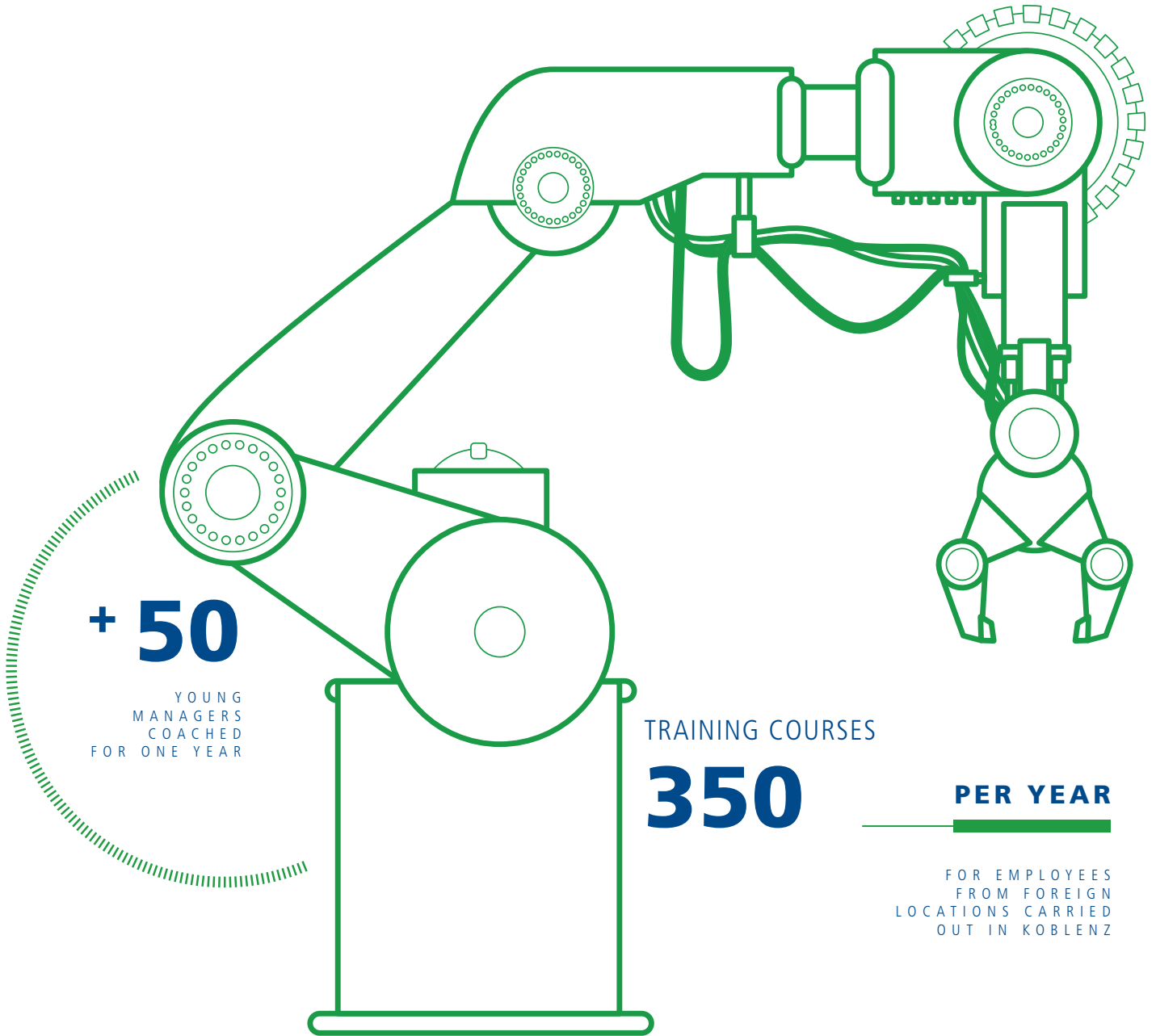

The pursuit of excellence is a powerful tool in corporate management. It requires employees to question their own actions in an innovative way each day, and encourages a positive no-blame culture in the company. That way, products, processes and services are continuously improved. Employees can help to shape their working environment, which is an important factor in staff retention.



» We want to delight our customers with excellent services and the highest level of product quality. «

**Joachim Balmert**  
VICE PRESIDENT  
QUALITY MANAGEMENT



The Stabilus Group pursues maximum excellence. This relates to all activities in the company and therefore, of course, to products, production processes and procedures. Stabilus has its roots in the automobile industry, where quality standards are among the most demanding in the world. Accordingly, Stabilus is committed to top product quality, and as a supplier to many sectors, feels a special responsibility to ensure that everyday items work reliably and safely.

This commitment applies to everything we make, from Stabilus gas springs in automobiles to dampers in solar parks to special structures, such as safety dampers that protect floodgates in the event of collisions with incoming ships.

For continuous improvement of its product quality, Stabilus uses established methods worldwide, including Kaizen, 5S and 6 Sigma. In addition, the company defines its own standards in order to establish robust processes across the board. These standards make key performance indicators more comparable across countries and departments and enable decisions to be taken even at short notice by means of management tools.

With this in mind, a uniform product-creation process underpinned by project-management software was introduced throughout the Group in the 2017 fiscal year, thus improving transparency across all regions, functions and business units.

Above and beyond product development and production, the content and structure of all other corporate functions are also geared towards supporting further growth. For instance, the HR department bolsters Stabilus' position as an employer in the competition for talent with corresponding programs and initiatives. Marketing and Sales are other departments where working methods are constantly honed and geared even more closely towards the needs of international customers with a view to attaining excellence.



» Our solid financing structure and excellence in finance processes contribute to the overall success of Stabilus. «

**Andreas Sievers**  
DIRECTOR GROUP  
ACCOUNTING AND STRATEGIC  
FINANCE PROJECTS



Stabilus has the ability to manufacture products of consistently high quality in both small and large batch sizes.

STAR 2025

# INNOVATION



Innovative Powerise® drives can open and close side doors.

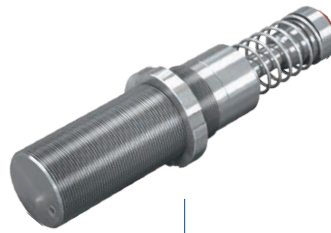

Industrial shock absorbers are customized innovations designed for specific applications.



Powerise® drives for tailgates have enabled additional convenience functions for passenger cars.

Stabilus believes that innovations are crucial to further sales growth. To ensure that the innovation pipeline remains continuously stocked in the future, the company is expanding its strong and vibrant innovation culture. Even greater use is to be made of the knowledge and experience of its often long-serving employees in the future.



Double-stroke gas springs, gas tension springs and new blockable gas springs supplement the product range and allow Stabilus to develop new solutions.



The combination of gas springs and an oil brake allows for the construction of the innovative sliding-door damper, a damping element particularly intended for heavy doors, windows and slide-in units.



» Global megatrends such as autonomous driving and digitalization are the inspiration for innovation at Stabilus. «

**David Sabet**

VICE PRESIDENT  
BUSINESS UNIT POWERISE



Throughout its history, Stabilus has constantly demonstrated the company's outstanding capacity for innovation. Many successful products and solutions now clearly show how well-placed the company is to develop market-ready products from innovations and establish them successfully as market standards. This success is particularly built on powerful production technologies that Stabilus develops to this day.

Nothing demonstrates the innovation capacity of Stabilus in the recent past more than the Powerise® technology. Thanks to its outstanding product properties, this electromechanical system, developed for automatic opening and closing of tailgates in the automobile sector, is now "the" solution for automatic operation of vehicle tailgates. The success of Powerise® is clearly apparent from the development of unit sales. While just a

million units were ordered in total in the first two years of series production up to 2012, more than 13 million Powerise® drives have now been sold to date. In addition, the Powerise® technology is no longer used solely in the automobile segment, but also increasingly in the industrial sector. It is also being constantly enhanced for new potential applications.

Many industries face major changes driven by trends such as digitalization, the Internet of Things, e-mobility and autonomous driving. The sharing economy and modern, flexible office environments with no permanently assigned workstations place new demands on the product developers of vehicle seats and office furniture. Stabilus sees all this as a huge opportunity. As a kinematics specialist with a diverse range of motion-control solutions, Stabilus will provide the right options for its customers. For instance, Stabilus is developing smart control technologies for its electromechanical spindles in order to extend their scope of application.



STAR 2025

# ONE STABILUS

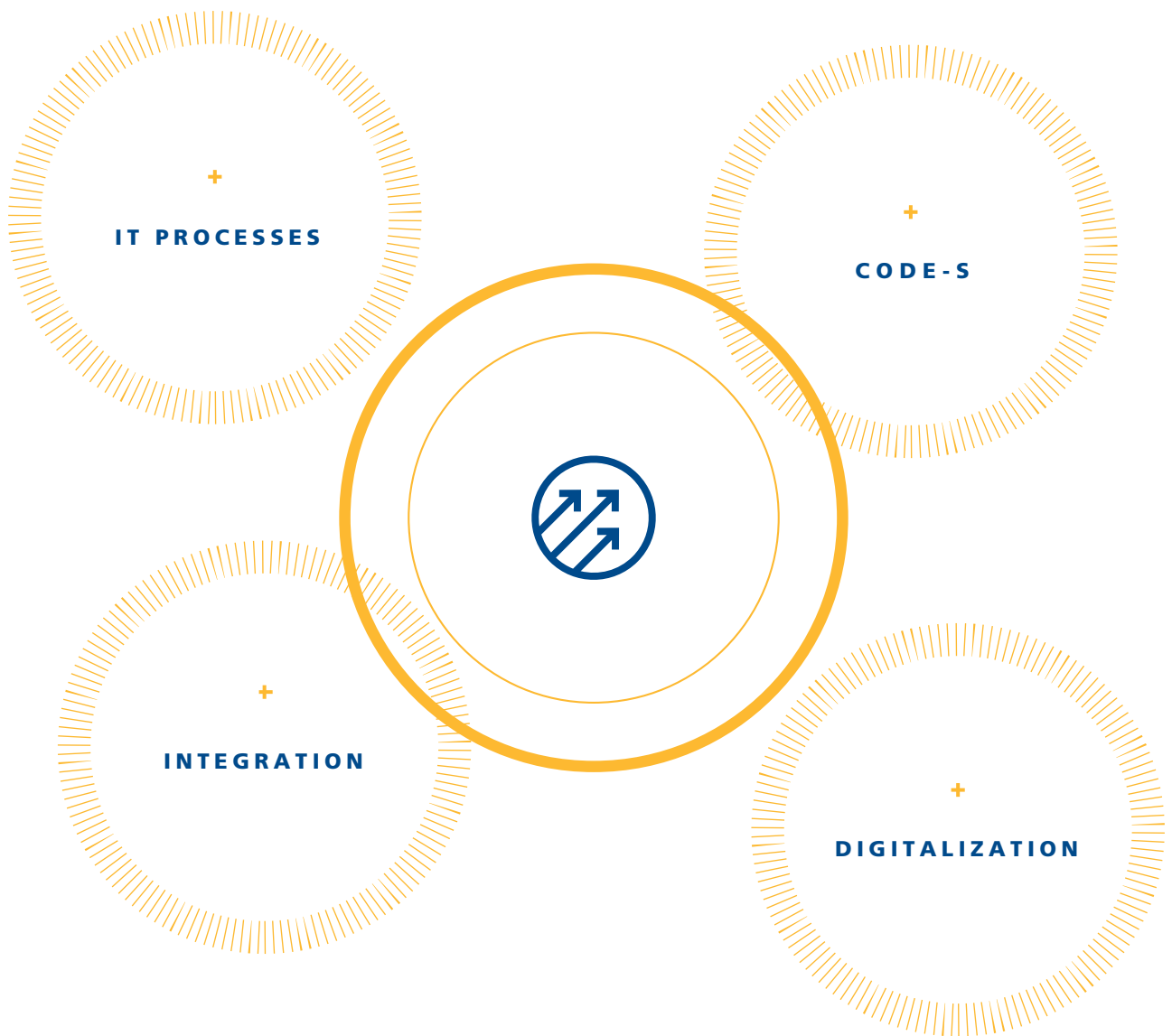

The Stabilus Group now has more than 6,000 employees, almost twice as many as in 2011. Our Group-wide team spirit as well as globally joined-up thinking and action form the basis for our past and future success.



» The STAR process has enabled smooth integration into the Stabilus Group. «

**Jürgen Roland**  
VICE PRESIDENT  
BUSINESS UNIT  
VIBRATION & VELOCITY  
CONTROL



» Standardized organizational structures as well as digital procurement processes have resulted in substantial efficiency gains. «

**Ekkehard Kadenbach**  
VICE PRESIDENT  
GLOBAL PURCHASING



» Our unique corporate culture and global positioning make us more attractive as an employer. «

**Martina Widmer**  
VICE PRESIDENT  
HUMAN RESOURCES



Capacity for integration is a key success factor for a globally fast-growing company. Stabilus will continue to grow in the future, while also moving closer together at organizational level, for instance through Group-wide simplification of processes and the IT infrastructure, as well as at team level. After all, Stabilus particularly relies on talented, motivated employees, and lasting success is based on all employees working together. To make even better use of the available potential, Stabilus has therefore devised across-the-board corporate values and embedded them throughout the Group under the name "CODE-S".

These values serve as a guide for day-to-day activities and help to reinforce the existing sense of togetherness in the company, thus boosting global team spirit. In every cultural milieu, it is important for employees to experience respect from colleagues and managers. The Stabilus corpo-

rate culture is designed with this in mind, as well as openness and dialog across all departments and hierarchy levels.

The Stabilus brand will be a crucial binding element here. Across the world, it stands for a company that is committed to an ambitious growth path and further challenging targets. Wide-ranging services for employees and the opportunity to help shape ongoing success in a changing company complete the picture of Stabilus as an attractive employer.

# STABILUS OUR VALUES

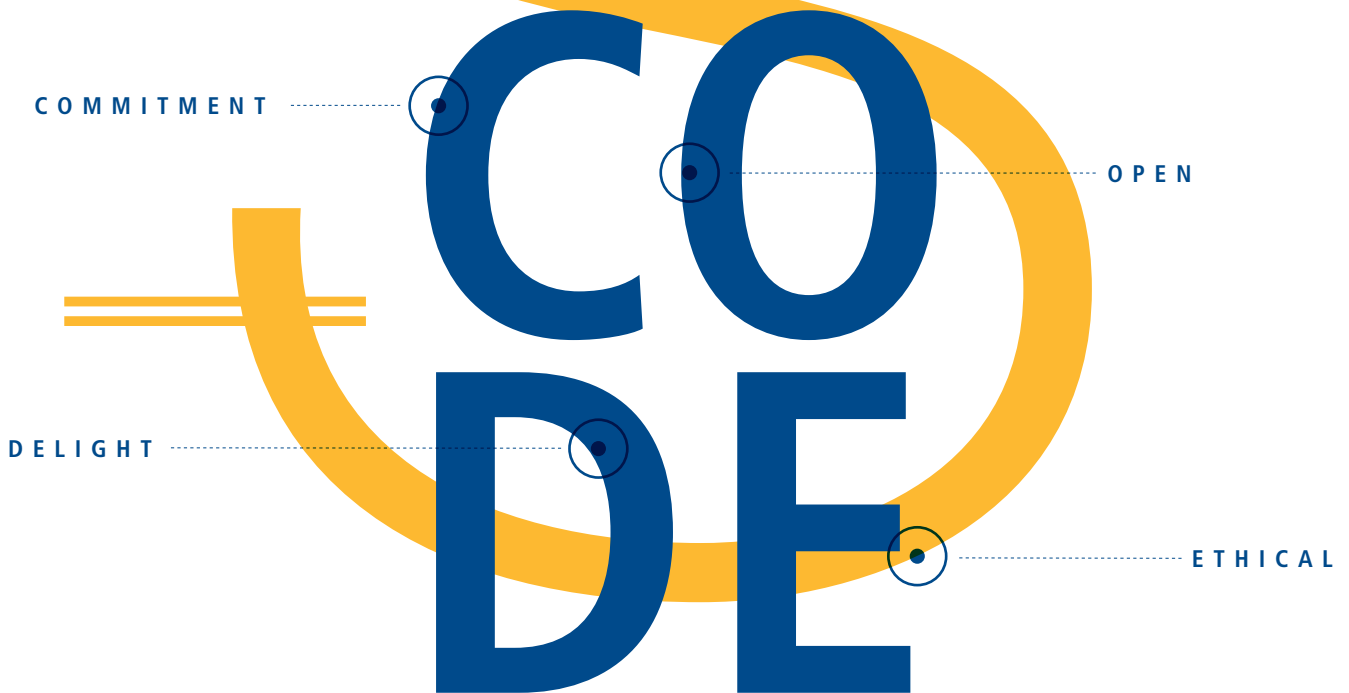

Four corporate values have been set out under the name CODE-S. They form an identification framework and describe the attitude with which all employees are expected to act at Stabilus. As a result, they forge identity and act as a guide for the various decisions that are made in day-to-day business.



» Commitment is what makes a goal become reality - the very successful development of our NAFTA activities since 2011 is proof of this. «

**Anthony Haba**  
REGIONAL HEAD  
NAFTA



» Delight to our customers starts with our people and their pride in our products, ideas and processes. «

**David Sabet**  
VICE PRESIDENT  
BUSINESS UNIT POWERISE



» Ethical conduct for Stabilus means that we treat our customers and suppliers with fairness, integrity as well as respect and our employees as part of our Stabilus family. «

**Xuefeng Tian**  
COUNTRY HEAD  
CHINA

However, as well as being important in dealings among colleagues and with customers, value orientation is also an essential success factor for Stabilus. After all, clear and well-formulated values are the foundation for further fast and successful integration of future acquisitions. The letters CODE represent the initials of our corporate values:

**Commitment**

This value expresses reliability and is characteristic of us according to internal surveys and numerous discussions with various stakeholders such as customers, employees, investors and business partners. Internally, the value embodies dedication, application and duty, or in short: I keep promises and make every effort to meet our targets.

**Open**

We are open to new ideas and promote diversity in our company as well as a good flow of information. All employees are important to the company and contribute to its success through dedicated cooperation and ideas.

**Delight**

Enthusiasm describes the excellence with which we work and always aim to impress customers, partners and colleagues by giving that little bit extra. The value also emphasizes our service quality as well as our enjoyment and persistence when it comes to finding the best solution.

**Ethical**

Our actions are typified by fairness and respect for each other. We operate within the law and in a spirit of trust, reliability and collegiality. With our current code of conduct, our employee programs and our extensive measures to protect the environment and resources, we have created the structural framework for systematically assessing this challenging aspiration and continuously improving our specific services.



# GROUP CONVENTION 2017



Change process require lots of communication and clarity regarding visions and targets. At the end of August 2017, Stabilus therefore held a global management conference, the "Group Convention", for the first time. Around 140 participants met at the world-famous Ehrenbreitstein Fortress in Koblenz. CEO Dietmar Siemssen and CFO Mark Wilhelms aroused their enthusiasm in the STAR 2025 strategy.



One aim of the conference was to inform the entire management level of the Stabilus Group of the new targets and forthcoming projects. To this end, the participants became key ambassadors for taking their enthusiasm for the new direction into the Group's locations. Following the Group Convention, they reported to their team members about the forthcoming projects and the corporate values, thus instigating the crucial change process for the organization at all Stabilus locations around the world.

Stabilus' success in the years since 2011 is based on rigorous implementation of the STAR 2020 strategy process, which spurred the employees to produce outstanding performance. Many of the targets defined in STAR 2020 were met ahead of schedule in 2017. Therefore, the challenge now is to raise enthusiasm for STAR 2025 among the 6,000-plus employees of the more diversified Stabilus Group. The wealth of experience and the confidence that employees will gain from the strategy process in the years ahead are another source of motivation for maximum performance: They will help Stabilus to reinvent itself again while remaining a reliable partner for its stakeholders, constantly focused on its customers' requirements.



The teams that showed particularly outstanding performance were recognized with the STAR Award.

Team spirit and an understanding of colleagues' tasks are strengths of Stabilus.







The corporate functions and business units presented their respective targets and strategies. As a result, the participants gained a shared understanding of the targets and projects up to 2025.





In his speech, CEO Dietmar Siemssen stressed that all participants have great responsibility. He underlined that the Stabilus teams positively stand out from other companies with their high level of initiative and willingness to cooperate.



During the Group Convention, the Innovation Lab encouraged sharing of expertise and constructive discussion regarding new ideas for products and production.

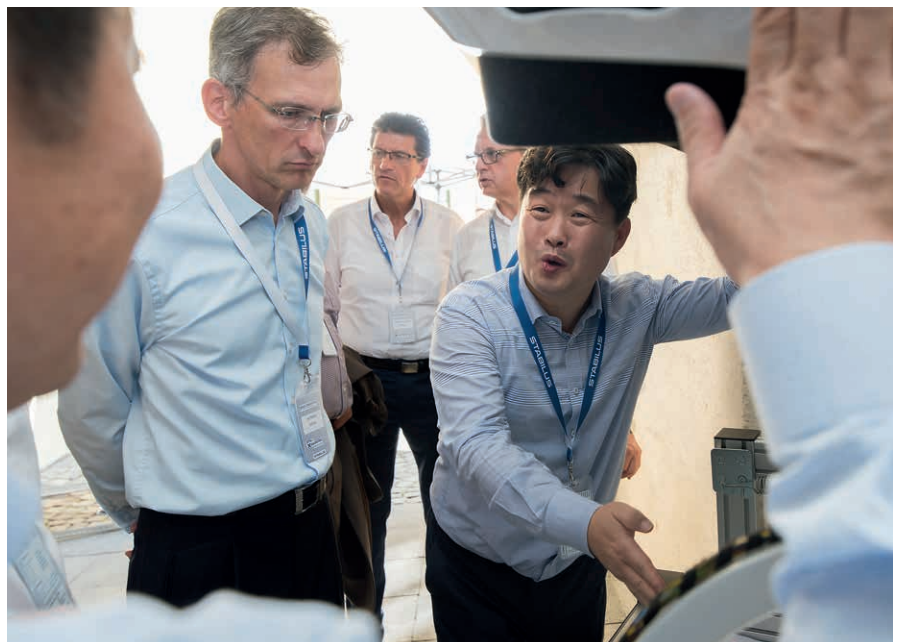

# STABILUS SHARE

## +48.5%

Stabilus' share price up by 48.5% in FY2017.

### Stabilus share data

Ticker symbol	STM
Bloomberg ticker symbol	STM:GR
Reuters ticker symbol	STAB.DE
ISIN	LU1066226637
German security identification number (WKN)	A113Q5
Number of shares outstanding (Sept 30, 2017)	24,700,000
Type of shares	Dematerialized shares with a nominal value of €0.01
Capital stock (Sept 30, 2017)	€247,000

### Stabilus share price up by 48.5%

Stabilus' share price increased by 48.5% over the course of the fiscal year 2017 (stock exchange trading days: Oct. 4, 2016 - Sept. 29, 2017) and once again substantially outperformed the peer indices: SDAX, DAXsector All Automobile and DAXsector Industrial.

### Shareholder structure

According to the voting rights notifications received until September 30, 2017, Marathon Asset Management LLP, London, UK and BlackRock, Inc., Wilmington, DE, USA each hold more than 5% of Stabilus shares. Stabilus management, i.e. members of the Management Board and of the Supervisory Board, hold 0.5% of the total shares.

The aforementioned and all other voting-right notifications are published on [www.ir.stabilus.com](http://www.ir.stabilus.com).

### Shareholder Structure

in % as of September 30, 2017

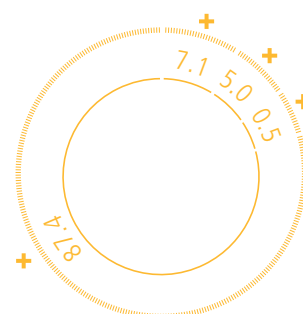

7.1%	Marathon Asset Management LLP
5.0%	BlackRock, Inc.
0.5%	Management
87.4%	Other institutional and private investors

Share price performance



Annual General Meeting

Approximately 56% of equity capital was represented at our Annual General Meeting which was held on February 15, 2017 in Luxembourg. Each of the agenda points proposed by the company’s management has been approved by a large majority of the shareholders. Among other things, the Articles of Association were amended and the share form was changed from bearer shares to dematerialized shares in accordance with Luxembourg Law on dematerialized shares dated April 6, 2013. All of the documents and information regarding the Annual General Meeting can be found at [www.ir.stabilus.com](http://www.ir.stabilus.com).

Dividend proposal of €0.80 per share

The Management Board and the Supervisory Board have resolved to propose a dividend distribution of €0.80 per share for FY2017 to the Annual General Meeting to be held in Luxembourg on February 14, 2018. In case the AGM approves the dividend proposal, the total dividend will thus amount to €19.8 million (PY: €12.4 million) and the distribution ratio will be 24.9% of the consolidated profit attributable to the Stabilus shareholders.

€0.80

The Management Board and Supervisory Board propose a dividend of €0.80 per share for FY2017.

### Development of Stabilus share price since IPO



### Regular dialog with investors and analysts

In fiscal year 2017 we continued to pursue our goal of providing all market participants with relevant and reliable information. We conducted ten roadshows in Europe's and North America's major financial centers and participated in the following international conferences:

- Oddo Forum, Lyon
- Commerzbank German Investment Seminar, New York
- Kepler Cheuvreux 16th German Corporate Conference, Frankfurt am Main
- Bankhaus Lampe Deutschlandkonferenz, Baden-Baden
- UBS Pan European Small and Mid-Cap Conference, London
- Commerzbank Mid Cap Investment Conference, Boston and New York
- Warburg Highlights Conference, Hamburg

- Berenberg European Conference USA, Tarrytown
- Societe Generale Nice Conference, Nice
- Quirin Champions, Frankfurt am Main
- J.P. Morgan 5th Annual Auto Conference, London
- Commerzbank Sector Conference, Frankfurt am Main
- Berenberg Goldman Sachs Sixth German Corporate Conference, Munich
- Baader Investment Conference, Munich
- Berenberg Madrid Seminar

In addition, in fiscal 2017, we hosted eight investor plant visits at the company's operational headquarters in Koblenz, Germany.

The number of equity analysts which publish regular assessments and recommendations on Stabilus stock increased from nine as of September 2016 to twelve as of September 2017.

### Research coverage

Bankhaus Lampe	Christian Ludwig
Berenberg	Philippe Lorrain, Simon Toennesen
Commerzbank	Yasmin Steilen
Equinet Bank	Manuel Tanzer, Stefan Augustin
Hauck & Aufhäuser	Christian Glowa
J.P. Morgan	Jose M Asumendi, Akshat Kacker
Kepler Cheuvreux	Hans-Joachim Heimbürger
Macquarie	Christian Breitsprecher
MainFirst	Florian Treisch
Oddo Seydler	Michael Junghans
Societe Generale	Stephen Reitman, Erwann Dagonne
Warburg Research	Alexander Wahl



COMBINED  
**MANAGEMENT  
REPORT**

CHAPTER

**B**

35 - 60



# COMBINED MANAGEMENT REPORT

as of and for the fiscal year ended September 30, 2017

37	GENERAL	48	LIQUIDITY
37	STRATEGY	51	STATUTORY RESULTS OF OPERATIONS AND FINANCIAL POSITION OF STABILUS S. A.
39	BUSINESS AND GENERAL ENVIRONMENT	51	RISKS AND OPPORTUNITIES
41	RESULTS OF OPERATIONS	57	CORPORATE GOVERNANCE
45	DEVELOPMENT OF OPERATING SEGMENTS	60	SUBSEQUENT EVENTS
46	FINANCIAL POSITION	60	OUTLOOK

## GENERAL

Stabilus S. A., Luxembourg, hereafter also referred to as "Stabilus" or the "Company" is a public limited liability company (société anonyme) incorporated in Luxembourg and governed by Luxembourg law. The registered office is 2, rue Albert Borschette, L-1246 Luxembourg, Grand Duchy of Luxembourg.

Stabilus S. A. is the parent company of the Stabilus Group. The Group is organized and managed primarily on a regional level. The three reportable operating segments of the Group are Europe, NAFTA as well as Asia / Pacific and Rest of World (RoW). Stabilus' fiscal year is not a calendar year but a twelve-month period from October 1 until September 30 of the following year.

The Stabilus Group is a leading manufacturer of gas springs, dampers as well as electromechanical tailgate opening systems (motion control solutions). The products are used in a wide range of applications in the automotive and the industrial sector, including furniture applications. Typically the products are used to aid the lifting and lowering or dampening of movements. As world market leader for gas springs, the Group manufactures for all key vehicle producers. A broad spectrum of industrial customers diversify the Group's customer base. Around 36% of Group's revenue in fiscal 2017 were achieved with industrial customers.

## STRATEGY

The Stabilus Group is a leading supplier of gas springs to automotive and industrial customers. In addition, the Company has successfully expanded into the production and sale of automatic opening and closing systems, primarily used in vehicle tailgates. With the acquisition of Hahn Gasfedern, ACE and Fabreka / Tech Products in fiscal 2016 the Group expanded its product offering. The Company offers now a broad range of solutions for motion control, which contains additional damping solutions including vibration insulation. Stabilus' strategic aim is to further extend its leadership positions. The key focus areas of its strategy STAR are to: (i) drive profitable and cash-generating growth, (ii) benefit from megatrends, such as increased standard of living, increasing comfort requirements and aging population, (iii) focus on innovative gas

spring solutions, especially in the industrial business through new applications and selected add-on acquisitions and (iv) maintain and strengthen the Company's cost and quality leadership.

### **DRIVE PROFITABLE AND CASH GENERATING GROWTH IN ALL REGIONAL SEGMENTS AND ACROSS END MARKETS**

The Stabilus Management aims to continue to increase revenue, profits and cash flows across all business segments by further focusing on regions and sectors where the Stabilus Group has room to grow, by entering new markets and by strengthening the Group with selected add-on acquisitions.

#### **Automotive Gas Spring & Powerise®: Focus on rapidly growing regions and increased comfort**

Stabilus intends to continue to further expand its international presence in rapidly growing markets, in particular in Asia, which has become a significant growth driver for the automotive sector and where the Company's market share still lags behind the market share in Europe and NAFTA. Management seeks to increase revenue from Asian OEMs in the automotive business, supported by new targeted investments in additional production capacity in this region. To achieve this goal, management has implemented a targeted sales strategy and is further strengthening engineering capabilities in China, which has already secured orders from several local Chinese OEMs.

Increased demand for SUVs, crossovers and hatchback cars will provide a strong foundation for increased Powerise® sales. Powerise®, our automatic opening and closing system for vehicle tailgates fulfills the increased comfort requirements across all regions. The Company is in the process of adding further capacities at its three Powerise® production plants.

#### **Industrial: Increase regional coverage**

While Stabilus has a large industrial market share in certain European countries in which the Company has a strong commercial presence, the Group believes that there is still potential to increase market share in Asia and North America, where the Company's market coverage is comparatively less strong. Management has identified regions and countries in which the Company has the opportunity to repeat the successful strategies from markets where Stabilus has a high share, by improving market coverage with the objective of strengthening the local sales footprint. In addition,



Stabilus intends to duplicate its production, application engineering and sales know-how from Europe and NAFTA to the Asia/Pacific region, to strengthen the Group's footprint there. The Company is increasing its presence in China. Stabilus has extended its Chinese production capabilities and set up local application engineering, sales and project management teams. In China the Company has set up the first production line for industrial products, which will help gain additional local market shares. The Stabilus management believes that a strong local presence in China will further strengthen the Group's position in the Asia / Pacific region.

#### **Commercial furniture: Supplying high quality products**

As the only non-Asian producer of gas springs for high quality commercial furniture, Stabilus is in an excellent position to gain further market share in Europe and NAFTA being the only non-Asian producer. Management has successfully turned around the commercial furniture business and increased profitability and stabilized revenues. Stabilus expects this positive momentum to continue.

#### **BENEFIT FROM MEGATRENDS, SUCH AS INCREASING COMFORT REQUIREMENTS AND AGING POPULATION**

Stabilus continues to adapt its product offerings towards megatrends, such as comfort requirements. The Powerise® solution enhances comfort through automatically opening and closing car tailgates and trunk lids. In addition, the Company's gas springs offer more comfortable opening and closing solutions as well as increased comfort in commercial furniture and industrial applications, such as airplane seats.

The global population of older people is growing considerably faster than the population as a whole. Stabilus focuses on capitalizing on this megatrend. It is inevitable that an aging consumer base requests more movement support and more automated systems in their vehicles and in other aspects of their daily lives. The Group intends to benefit from this megatrend as it has a leading position as a system provider of automatic opening and closing systems which will continue to experience an increasing demand.

#### **FOCUS ON INNOVATIVE COMPONENTS AND SYSTEMS TO TAKE ADVANTAGE OF GLOBAL INDUSTRY TRENDS**

The products of Stabilus are at the forefront of innovation in motion control. The Company employs 329 people in R&D across its three regional segments as of September 30, 2017. Stabilus is focused on designing and manufacturing highly-engineered components, modules and system solutions that address key global trends in the automotive and industrial sectors. The Company aims to adapt to these trends by continuously improving its existing technology, in particular the requirement for ergonomic solutions as well as automated opening and closing systems. Management believes that actively addressing these key trends reinforces the Company's ability to maintain its market share and profitability.

In the industrial sector, the Company continues to develop products for enhanced safety and comfort. For example, it is selling a seat application based on the Bloc-O-Lift® system for use in airplane seats. In addition, dampers manufactured by Stabilus are increasingly used in suntracking solar panels. Our dampers protect the modules by reducing wind induced vibration.

Management expects that recent and continued wins at / from key clients for Powerise® solutions due to the superior technology features of the Company's products will be a key growth driver for Stabilus. While Powerise® systems were in the past deployed only in the luxury and SUV car segments, Powerise® has recently successfully gained market shares with mid-class vehicles such as the VW Passat and Ford Mondeo. The Company is working on and investing in improving and further developing its current spindle drive technology to further reduce noise, weight and cost. In addition, Stabilus is exploring new industrial applications for its Powerise® systems.

#### **MAINTAIN AND STRENGTHEN COST AND QUALITY LEADERSHIP**

##### **Build on the Group's global footprint and proximity to customers**

Based on Stabilus guiding strategy "in the region, for the region", it has established its facilities in close proximity to the Group's customers and has done so continuously over the past years e.g. the US, in China, South Korea, Mexico. It is the Company's goal to continue to provide a comprehensive product and service offering to



current and new customers globally. The Group seeks to fully globalize its product portfolio and to provide an even broader range of components and systems to each customer.

#### **Continue to optimize cost base**

Stabilus continuously implements operational improvements relating to plant and overhead, which includes productivity improvements, overhead optimization and the rollout / implementation of local sourcing, to improve the Company's operating cost.

For the coming years, management expects to continue on this path with productivity improvements, a range of initiatives to profitability backed by a high level of business which has already been locked in. Due to the Company's production know-how and long-standing client relationships backed by Stabilus' quality leadership, management is confident that it can protect the Group's market shares in gas springs in Europe and NAFTA and gain further market shares for gas springs in the Asia / Pacific region, especially with local customers. An increasing market share in Powerise® supports the positive outlook.

## **BUSINESS AND GENERAL ENVIRONMENT**

Stabilus Group operates in automotive and in industrial markets.

In the industrial markets, we supply customers in a large number of sub-industries, e.g. industrial production equipment, automation, construction machinery, transportation (aircraft, truck and buses, marine), agriculture machinery, medical applications, renewable energy (in particular solar, wind). Hence, our revenue development in the industrial business depends to a certain degree on the macroeconomic development, i.e. the growth rate of the gross domestic product (GDP) in the countries and regions we operate in.

In the automotive market, an important driver of our revenue growth is the global production volume of light vehicles (which comprise passenger cars and light commercial vehicles weighing less than six tons) and ultimately the number of vehicles sold, e.g. the registration of new vehicles as an indicator of car sales. The average content of Stabilus products per vehicle differs with the car body configurations (for instance, hatchbacks and SUVs have generally a higher content per car). Hence, the demand and popularity of certain vehicle body configurations should be considered as an additional variable in a revenue forecast model.

### **Macroeconomic development**

According to the latest figures published by the International Monetary Fund (IMF), the global GDP growth in the calendar year 2017 is expected to be 3.6% (2016: 3.2%). Advanced economies experienced persistent stagnation in the last years and currently show a change for the better: the increase of the established economies' GDP is expected to be 2.2% in 2017 and 2.0% in 2018, compared to 1.7% in calendar year 2016. The developing economies are still experiencing higher growth rates as last year. The growth rate of developing countries' GDP is expected to be 4.6% in 2017 and 4.9% in 2018, compared to 4.3% in 2016.

## Latest growth projections for selected economies

T\_001

% YEAR-ON-YEAR CHANGE IN THE CALENDAR YEAR	2016	2017*	2018*
<b>World</b>	<b>3.2%</b>	<b>3.6%</b>	<b>3.7%</b>
<b>Advanced economies</b>	<b>1.7%</b>	<b>2.2%</b>	<b>2.0%</b>
Euro Area	1.8%	2.1%	1.9%
United Kingdom	1.8%	1.7%	1.5%
United States	1.5%	2.2%	2.3%
Canada	1.5%	3.0%	2.1%
Japan	1.0%	1.5%	0.7%
<b>Developing economies (emerging markets)</b>	<b>4.3%</b>	<b>4.6%</b>	<b>4.9%</b>
Emerging and developing Europe	3.1%	4.5%	3.5%
Russia	(0.2)%	1.8%	1.6%
China	6.7%	6.8%	7.4%
Mexico	2.3%	2.1%	1.9%
Brazil	(3.6)%	0.7%	1.5%

Source: IMF, October 2017 World Economic Outlook.  
\* Projections.

## Development of vehicle markets

The global production of light vehicles in the last twelve months developed positively. According to IHS forecasts as of October 2017, the global production is expected to increase from 93.0 million units in calendar year 2016 to approximately 95.1 million vehicles in 2017 which corresponds to a growth rate of 2.2% in 2017. Thus, in 2017, the output of new passenger cars and light commercial vehicles is forecast to reach around 55.6 million vehicles (+3.5% versus 53.7 million units in 2016) in Asia/Pacific and RoW, approximately 22.3 million vehicles (+3.7% versus 21.5 million units in

2016) in Europe and around 17.2 million vehicles (–3.3% versus 17.8 million units in 2016) in the NAFTA region.

Estimations of the German Association of the Automotive Industry (VDA), as of October 2017, show a global year-on-year increase of new car registrations in calendar year 2017 amounting to approximately 2%. The development varies significantly in the world's regions: +10% in Eastern Europe, +2% in Mexico, +2% in China, +3% in Western Europe, –4% in the USA, +10% in Russia and +5% in Brazil.

## Production of light vehicles

T\_002

IN MILLIONS OF UNITS PER CALENDAR YEAR	2013	2014	2015	2016	2017**	2018**
Europe	19.5	20.1	21.0	21.5	<b>22.3</b>	22.7
NAFTA	16.2	17.0	17.5	17.8	<b>17.2</b>	17.5
Asia / Pacific and RoW	49.0	50.2	50.3	53.7	<b>55.6</b>	56.4
<b>Worldwide production of light vehicles*</b>	<b>84.7</b>	<b>87.4</b>	<b>88.8</b>	<b>93.0</b>	<b>95.1</b>	<b>96.6</b>

Source: IHS  
\* Passenger cars and light commercial vehicles (<6t)  
\*\* IHS forecast as of October 2017

Sport utility vehicles (SUV), multi-purpose vehicles (MPV), crossovers, as well as station wagons and hatchbacks continue to be favored by an increasing number of end customers – not only in North America and Europe, but increasingly in Asia / China. For instance: the German Department of Motor Vehicles (Kraftfahrt-Bundesamt, KBA), a government agency administering vehicle registrations, publishes monthly statistics of new passenger car registrations on its website – classified by car models and vehicle segments. According to these statistics for 2016, registrations of new SUVs in Germany increased by 20.1% in a year-on-year comparison and off-road vehicles by 10.4% – i.e. more strongly than other vehicle segments and total new car registrations which increased by 4.5%. In the ten-month period from January to Octo-

ber 2017, the registrations of new SUVs in Germany increased by 18.4% and the registrations of new off-road vehicles by 3.6%, compared to the respective period of the previous year.

## RESULTS OF OPERATIONS

The table below sets out Stabilus Group's consolidated income statement for the fiscal year 2017 in comparison to the fiscal year 2016:

### Income statement

T\_003

IN € MILLIONS	Year ended Sept 30,			
	2017	2016	Change	% change
Revenue	910.0	737.5	172.5	23.4%
Cost of sales	(637.2)	(547.7)	(89.5)	16.3%
<b>Gross profit</b>	<b>272.9</b>	<b>189.8</b>	<b>83.1</b>	<b>43.8%</b>
Research and development expenses	(38.2)	(26.6)	(11.6)	43.6%
Selling expenses	(80.4)	(55.5)	(24.9)	44.9%
Administrative expenses	(35.3)	(33.9)	(1.4)	4.1%
Other income	12.8	12.0	0.8	6.7%
Other expenses	(13.3)	(9.2)	(4.1)	44.6%
<b>Profit from operating activities (EBIT)</b>	<b>118.4</b>	<b>76.6</b>	<b>41.8</b>	<b>54.6%</b>
Finance income	22.3	2.6	19.7	>100.0%
Finance costs	(29.8)	(13.3)	(16.5)	>100.0%
<b>Profit / (loss) before income tax</b>	<b>110.9</b>	<b>65.9</b>	<b>45.0</b>	<b>68.3%</b>
Income tax income/ (expense)	(31.7)	(18.0)	(13.7)	76.1%
<b>Profit / (loss) for the period</b>	<b>79.2</b>	<b>48.0</b>	<b>31.2</b>	<b>65.0%</b>

## Revenue

Group's total revenue developed as follows:

### Revenue by region

T\_004

IN € MILLIONS	Year ended Sept 30,		Change	% change
	2017	2016		
Europe <sup>1)</sup>	456.3	364.2	92.1	25.3%
NAFTA <sup>1)</sup>	350.7	289.0	61.7	21.3%
Asia / Pacific and RoW <sup>1)</sup>	103.0	84.3	18.7	22.2%
<b>Revenue<sup>1)</sup></b>	<b>910.0</b>	<b>737.5</b>	<b>172.5</b>	<b>23.4%</b>

<sup>1)</sup> Revenue breakdown by location of Stabilus company (i. e. "billed-from view").

### Revenue by markets

T\_005

IN € MILLIONS	Year ended Sept 30,		Change	% change
	2017	2016		
Automotive Gas Spring	340.5	320.0	20.5	6.4%
Automotive Powerise	243.2	195.3	47.9	24.5%
Automotive business	583.7	515.3	68.4	13.3%
Industrial / Capital Goods	204.4	171.0	33.4	19.5%
Vibration & Velocity Control	93.9	22.5	71.4	>100.0%
Commercial Furniture	28.0	28.6	(0.6)	(2.1%)
Industrial business	326.3	222.2	104.1	46.8%
<b>Revenue</b>	<b>910.0</b>	<b>737.5</b>	<b>172.5</b>	<b>23.4%</b>

Total revenue of €910.0 million in fiscal year 2017 increased by 23.4% compared to the fiscal year 2016. The entities acquired in June 2016 (ACE, Hahn Gasfedern, Fabreeka and Tech Products) contributed €117.6 million in fiscal year 2017 and €27.3 million in fiscal 2016. The contribution of the entities acquired in June 2016 in fiscal 2016 reflects only the revenue starting from the date of acquisition, i.e. July 2016 to September 2016 (3 months or Q4 / 16).

In fiscal year 2017, revenue of our European entities increased by 25.3% from €364.2 million in fiscal 2016 to €456.3 million in fiscal 2017. The entities acquired in June 2016 contributed €75.9 million in fiscal year 2017 and €17.4 million in fiscal 2016 to Europe's revenue. The Powerise® business grew by €18.4 million or 22.5%.

NAFTA's revenue increased by 21.3% from €289.0 million in fiscal 2016 to €350.7 million in fiscal 2017. ACE, Fabreeka and Tech Products contributed €37.0 million in fiscal 2017 and €9.0 million in fiscal 2016 to NAFTA's revenue. The Powerise® business grew by €25.1 million or 22.3%. Approximately €2.0 million of NAFTA's revenue increase was due to the stronger US dollar, i.e. due to the currency translation of NAFTA's revenue from US dollar to euro (average rate per €1: \$1.10 in FY17 versus \$1.11 in PY).

Revenue of our entities in Asia / Pacific and RoW increased by 22.2% from €84.3 million in fiscal 2016 to €103.0 million in fiscal 2017. This is essentially due to new customer wins and a recovering of the business in South America. The entities acquired in June 2016 contributed €4.7 million in fiscal 2017 and €1.0 million in fiscal 2016 to the revenue increase in Asia / Pacific and RoW.



Revenue in the Automotive business increased by €68.4 million or 13.3% to €583.7 million (PY: €515.3 million). This is particularly due to our Powerise® business. The increase in the Powerise® business by 24.5% is mainly the result of further new OEM platform wins and the subsequent launch of new Powerise® programs for a number of key vehicle OEMs. In addition, the share of end customers (buyers of new vehicles) opting for this extra equipment continues to rise as well.

Revenue in the Industrial business increased by €104.1 million or 46.8% to €326.3 million (PY: €222.2 million). This is especially due to the acquisition in June 2016. ACE, Fabreeka and Tech Products form the new business unit Vibration & Velocity Control with €93.9 million revenue in fiscal 2017 (PY: €22.5 million). Hahn Gasfedern is part of the business unit Industrial / Capital Goods and contributed further €23.7 million (PY: €4.8 million) revenue. Commercial Furniture (formerly: Swivel Chair) revenue decreased by 2.1% from €28.6 million in fiscal 2016 to €28.0 million in fiscal 2017.

## Cost of sales and overhead expenses

### COST OF SALES

Cost of sales increased from €(547.7) million in fiscal 2016 by 16.3% to €(637.2) million in fiscal 2017 and this is generally driven by increased revenue. The cost of sales increase (16.3%) is less than the increase in revenue (23.4%). Consequently the cost of sales as a percentage of revenue decreased to 70.0% (PY: 74.3%) and the gross profit margin improved to 30.0% (PY: 25.7%). This reflects a stronger gross profit margin of the companies acquired in June 2016 and a better fixed cost absorption due to economies of scale. The companies acquired in June 2016, Hahn Gasfedern, ACE and Fabreeka / Tech Products, are active in the industrial market and offer custom made products with small lot sizes combined with short lead times. This market approach provides the mentioned stronger gross profit margins to Stabilus. At the same time this approach drives higher overhead cost and requires a different manufacturing approach, relative to the Automotive business.

### R&D EXPENSES

R&D expenses (net of R&D cost capitalization) increased by 43.6% from €(26.6) million in fiscal 2016 to €(38.2) million in fiscal 2017. As a percentage of revenue, R&D expenses increased by 60 basis

points to 4.2% (PY: 3.6%). The capitalization of R&D expenses decreased from €(12.6) million in fiscal 2016 to €(11.4) million in fiscal 2017.

### SELLING EXPENSES

Selling expenses increased from €(55.5) million in fiscal 2016 by 44.9% to €(80.4) million in fiscal 2017 generally due to increased revenue. As a percentage of revenue, the selling expenses increased to 8.8% (PY: 7.5%). This reflects the variable cost elements in selling expenses and the relatively higher selling expense to sales ratio of the entities acquired in June 2016 relative the other entities of the Group. The acquired entities are active in the industrial market which tends to have higher selling expense ratios compared to the automotive business.

### ADMINISTRATIVE EXPENSES

Administrative expenses increased from €(33.9) million in fiscal 2016 by 4.1% to €(35.3) million in fiscal 2017. This increase is essentially due to the entities acquired in June 2016. In fiscal 2016 non-recurring transaction cost of €(3.9) million relating to the acquisition were recognized. Overall payroll inflation and full year cost of the entities acquired in June 2016 explain the year-over-year increase in administrative expenses. As a percentage of revenue, administrative expenses decreased by 70 basis points to 3.9% (PY: 4.6%).

### OTHER INCOME AND EXPENSE

Other income increased from €12.0 million in fiscal 2016 by €0.8 million to €12.8 million in fiscal 2017. This mainly comprises foreign currency translation gains from the operating business.

Other expense increased from €(9.2) million in fiscal 2016 by €(4.1) million to €(13.3) million in fiscal 2017. This mainly comprises foreign currency translation losses from the operating business.

### FINANCE INCOME AND COSTS

Finance income is substantially due to the adjustment of the carrying value of the euro term loan facility amounting to €22.1 million. This reflects the decrease in the margin based on the improved net leverage ratio of the Group with an amount of €17.5 million and the extension of the term by one year with an amount of €4.6 million.

Finance costs increased from €(13.3) million in fiscal 2016 to €(29.8) million in fiscal 2017. This is primarily due to higher net foreign exchange losses in fiscal 2017.

The net foreign exchange loss is substantially due to the weaker USD (closing rate per €1: \$1.12 as at September 30, 2016 versus \$1.18 as at September 30, 2017) relevant for the translation of intragroup loans and the portion of the euro term loan facility (€157.5 million) held by an US entity until September 29, 2017.

Interest expenses on financial liabilities include ongoing interest expenses of €(9.6) million (PY: € 8.9 million) related to the euro term loan facility. Thereof, an amount of €(2.4) million (PY: €(2.6) million) is due to the amortization of debt issuance cost and the amortization of the adjustment of the carrying value by using the effective interest rate method. Furthermore the prepayments of the euro term loan facility lead to a derecognition of unamortized debt issuance cost and unamortized adjustment of the carrying value with a total amount of €(3.1) million (PY: €(3.8) million).

## INCOME TAX EXPENSE

Driven essentially by higher pre-tax profit of €110.9 million in fiscal 2017 (PY: €65.9 million), the income tax expense grew from €(18.0) million in fiscal 2016 to €(31.7) million in fiscal 2017. The tax rate in fiscal 2017 is 28.6% (PY: 27.3%). This increase reflects income taxes on dividend payments within the Stabilus Group.

## RECONCILIATION OF EBIT TO ADJUSTED EBIT

The following table shows a reconciliation of EBIT (earnings before interest and taxes) to adjusted EBIT for the fiscal years 2017 and 2016:

Adjusted EBIT represents EBIT, adjusted for exceptional non-recurring items (e.g. restructuring or one-time advisory costs) and depreciation / amortization of fair value adjustments from purchase price allocations (PPAs).

### Reconciliation of EBIT to adjusted EBIT

T\_006

IN € MILLIONS	Year ended Sept 30,			
	2017	2016	Change	% change
<b>Profit from operating activities (EBIT)</b>	<b>118.4</b>	<b>76.6</b>	<b>41.8</b>	<b>54.6%</b>
Advisory	–	3.9	(3.9)	(100.0)%
PPA adjustments	19.2	17.1	2.1	12.3%
Total adjustments	19.2	21.0	(1.8)	(8.6)%
<b>Adjusted EBIT</b>	<b>137.6</b>	<b>97.7</b>	<b>39.9</b>	<b>40.8%</b>

Adjusted EBIT is presented because we believe it is a useful indicator of the Group's operating performance before items which are considered exceptional and not relevant to an assessment of our operational performance.

In fiscal year 2017, the definition of adjusted EBIT has been slightly modified as interest cost on pensions recognized in EBIT will not be adjusted out anymore. The presentation of prior periods has been changed accordingly, i.e. the adjusted EBIT reported in our annual report for the fiscal year 2016 was €1.1 million higher.

The adjustment of advisory expenses amounting to €3.9 million in fiscal 2016 relates to the acquisition of ACE, Hahn Gasfedern, Fabreeka and Tech Products.

The PPA adjustments in the current year contain €10.8 million (PY: €12.7 million) related to the April 2010 PPA and €8.4 million (PY: €4.4 million) to the June 2016 PPA.

## DEVELOPMENT OF OPERATING SEGMENTS

Stabilus Group is organized and managed primarily on a regional level. The three reportable operating segments of the Group are Europe, NAFTA, Asia / Pacific and RoW.

The table below sets out the development of our operating segments for the fiscal years 2017 and 2016.

### Operating segments

T\_007

IN € MILLIONS	Year ended Sept 30,			
	2017	2016	Change	% change
<b>Europe</b>				
External revenue <sup>1)</sup>	456.3	364.2	92.1	25.3%
Intersegment revenue <sup>1)</sup>	30.4	28.0	2.4	8.6%
Total revenue <sup>1)</sup>	486.7	392.2	94.5	24.1%
Adjusted EBIT	68.0	52.9	15.1	28.5%
as % of total revenue	14.0%	13.5%		
as % of external revenue	14.9%	14.5%		
<b>NAFTA</b>				
External revenue <sup>1)</sup>	350.7	289.0	61.7	21.3%
Intersegment revenue <sup>1)</sup>	24.7	9.6	15.1	>100.0%
Total revenue <sup>1)</sup>	375.4	298.5	76.9	25.8%
Adjusted EBIT	55.1	33.4	21.7	65.0%
as % of total revenue	14.7%	11.2%		
as % of external revenue	15.7%	11.6%		
<b>Asia / Pacific and RoW</b>				
External revenue <sup>1)</sup>	103.0	84.3	18.7	22.2%
Intersegment revenue <sup>1)</sup>	0.7	0.8	(0.1)	(12.5)%
Total revenue <sup>1)</sup>	103.7	85.1	18.5	21.7%
Adjusted EBIT	14.5	11.3	3.2	28.3%
as % of total revenue	14.0%	13.3%		
as % of external revenue	14.1%	13.4%		

<sup>1)</sup> Revenue breakdown by location of Stabilus company (i. e. "billed-from view").

The external revenue generated by our European companies increased by 25.3% from €364.2 million in fiscal 2016 to €456.3 million in fiscal 2017. A significant portion of the revenue growth, i.e. €58.5 million (PY: €17.4 million), was contributed by the entities acquired in June 2016. Hahn Gasfedern which is part of our Industrial / Capital Goods business unit contributed €18.9 million in fiscal 2017 (PY: €4.8 million) and ACE, Fabreeka and Tech Products which form the business unit Vibration & Velocity Control contributed €52.2 million in fiscal year 2017 (PY: €12.6 million) to Europe's revenue. In addition, €18.4 million revenue increase was generated by our Powerise® business. Europe's organic revenue growth without the entities acquired in June 2016 is 9.7%. The adjusted EBIT of the European segment increased by 28.5% or €15.1 million and the adjusted EBIT margin, i.e. adjusted EBIT in percent of external revenue, increased by 40 basis points to 14.9% in fiscal 2017 (PY: 14.5%).

The external revenue of our companies located in the NAFTA region increased from €289.0 million in fiscal 2016 by 21.3% to €350.7 million in fiscal 2017. An amount of €28.0 million was contributed by the entities acquired in June 2016. ACE, Fabreeka and Tech Products contributed €37.0 million in fiscal year 2017 (PY: €9.0 million)

to NAFTA's revenue. In addition a €25.1 million revenue increase was generated by our Powerise® business. NAFTA's organic revenue growth without the entities acquired in June 2016 is 11.3% (currency adjusted). The adjusted EBIT of the NAFTA segment increased by 65.0% or €21.7 million and the adjusted EBIT margin, i.e. adjusted EBIT in percent of external revenue, increased by 410 basis points to 15.7% in fiscal 2017 (PY: 11.6%).

The external revenue of our companies located in the Asia / Pacific and RoW region increased from €84.3 million in fiscal 2016 by 22.2% to €103.0 million in fiscal 2017. An amount of €3.7 million was contributed by the entities acquired in June 2016. ACE, Fabreeka and Tech Products contributed €4.7 million in fiscal year 2017 (PY: €1.0 million) to Asia / Pacific and RoW. In addition an €8.8 million revenue increase was generated by our Automotive Gas Spring business and another €4.4 million by our Powerise® business. Asia / Pacific and RoW organic revenue growth without the entities acquired in June 2016 is 18.0%. The adjusted EBIT of the Asia / Pacific and RoW segment increased by 28.3% or €3.2 million and the adjusted EBIT margin, i.e. adjusted EBIT in percent of external revenue, increased by 70 basis points to 14.1% in fiscal 2017 (PY: 13.4%).

## FINANCIAL POSITION

### Balance sheet

T\_008

IN € MILLIONS	2017	2016	Change	% change
<b>Assets</b>				
Non-current assets	647.8	671.9	(24.1)	(3.6)%
Current assets	282.2	265.6	16.6	6.2%
<b>Total assets</b>	<b>930.0</b>	<b>937.4</b>	<b>(7.4)</b>	<b>(0.8)%</b>
<b>Equity and liabilities</b>				
Total equity	336.4	262.9	73.5	28.0%
Non-current liabilities	430.8	522.4	(91.6)	(17.5)%
Current liabilities	162.8	152.1	10.7	7.0%
Total liabilities	593.6	674.5	(80.9)	(12.0)%
<b>Total equity and liabilities</b>	<b>930.0</b>	<b>937.4</b>	<b>(7.4)</b>	<b>(0.8)%</b>



## TOTAL ASSETS

The Group's balance sheet total decreased slightly from €937.4 million as of September 30, 2016 by (0.8%) to €930.0 million as of September 30, 2017.

## NON-CURRENT ASSETS

Our non-current assets decreased from €671.9 million as of September 30, 2016 by (3.6%) or €(24.1) million to €647.8 million as of September 30, 2017. This reduction is mainly attributable to the €(26.9) million decrease of other intangible assets that results from the ongoing amortization of intangible assets from the purchase price allocations 2010 and 2016, but also to foreign exchange rate-related carrying value adjustments, e.g. a decrease in goodwill of €(3.3) million. This decrease was partly offset by ongoing capacity expansion projects.

## CURRENT ASSETS

Current assets increased from €265.6 million as of September 30, 2016 by 6.2% or 16.6 million to €282.2 million as of September 30, 2017. This is essentially the consequence of an increase in inventories of €10.6 million and trade accounts receivables of €7.5 million that reflect our ongoing revenue growth. This is partly offset by a decrease of €(6.9) million in cash and cash equivalents reflecting three prepayments of the term loan facility with a total amount of €(62.5) million and €(12.4) million dividend payments. These payments are substantially covered by the strong free cash flow and thus only lead to a slight decrease in the cash balance.

## EQUITY

The Group's equity as of September 30, 2017 increased from €262.9 million as of September 30, 2016 by €73.5 million to €336.4 million as of September 30, 2017. This increase results

mainly from the profit for the period amounting to €79.2 million that was generated in the fiscal year 2017 and from other comprehensive income of €6.6 million that comprises unrealized actuarial gains on pensions (net of tax) and unrealized foreign currency translation gains. In the second quarter of fiscal 2017 dividends amounting to €(12.4) million were paid to our shareholders and led to a corresponding decrease of the equity balance.

## NON-CURRENT LIABILITIES

Non-current liabilities decreased from €522.4 million as of September 30, 2016 by €91.6 million to €430.8 million as of September 30, 2017. This decrease is mainly due to three prepayments of the term loan facility amounting to €(62.5) million and to adjustments of the carrying amount of the euro term loan facility by €(22.1) million reflecting the margin decrease due to the improved net leverage ratio of the Group and the extension of the term by one year. In addition, the pension liability decreased by €(5.5) million. This is substantially the effect of an increased discount rate (1.35% as at September 30, 2016 versus 1.87% as at September 30, 2017).

## CURRENT LIABILITIES

Current liabilities increased from €152.1 million as of September 30, 2016 by €10.7 million to €162.8 million as of September 30, 2017. This is primarily due to the increase in current financial liabilities by €5.0 million reflecting the increase in expected prepayments of the euro term loan facility in the next twelve months and the increase of current tax liabilities by €4.7 million based on higher taxable income.

## LIQUIDITY

### CASH FLOW FROM OPERATING ACTIVITIES

Cash flow from operating activities increased by €11.5 million from €110.4 million in fiscal 2016 to €121.9 million in fiscal 2017. This increase is mainly due to the strong revenue and earnings growth and partly offset by higher net working capital as a consequence of the continuing growth and shorter payment cycles for trade payables.

### CASH FLOW FROM INVESTING ACTIVITIES

Cash outflow for investing activities decreased from €(348.8) million in fiscal 2016 to €(44.1) million in fiscal 2017. The prior year figures include the cash outflow of €(302.5) million (net of cash acquired) for the acquisition of ACE, Hahn Gasfedern, Fabreeka and Tech Products. The capital expenditures, i.e. the purchase of property plant and equipment and intangible assets, decreased from €(53.7) million in fiscal 2016 to €(45.1) million in fiscal 2017. See Consolidated Statement of Cash Flows for further details.

Excluding the cash outflow for the acquisition of €(302.5) million and corresponding currency hedging proceeds of €6.8 million in fiscal 2016, the cash outflow for investing activities decreased from €(53.1) million in fiscal 2016 to €(44.1) million in fiscal 2017.

### CASH FLOW FROM FINANCING ACTIVITIES

Cash flow from financing activities decreased from a cash inflow of €276.1 million in fiscal 2016 to an outflow of €(83.7) million in fiscal 2017. The current year cash outflow resulted primarily from the €(62.5) million prepayments of the euro term loan facility, the €(12.4) million dividend payments made to our shareholders in February 2017 and €(8.3) million interest payments.

The prior year cash inflow mainly results from the issuance of a new €455.0 million euro term loan facility and €159.1 million proceeds from the capital increase that were used to refinance the Group's previous term loan facility amounting to €267.5 million and for the acquisition of ACE, Hahn Gasfedern, Fabreeka and Tech Products in June 2016. The prior year receipts under the senior facilities also comprised an equity bridge facility amounting to €115.0 million that was settled after the capital increase in July 2016. See Consolidated Statement of Cash Flows for further details.

The payments for interest increased from €(7.0) million in fiscal 2016 to €(8.3) million in fiscal 2017. This is generally reflects the increase in financial liabilities following the acquisition in June 2016, but due to the lower interest rates this only slightly increases the interest payments.

### Cash flows

T\_009

IN € MILLIONS	Year ended Sept 30,			
	2017	2016	Change	% change
Cash flow from operating activities	121.9	110.4	11.5	10.4%
Cash flow from investing activities	(44.1)	(348.8)	304.7	(87.4%)
Cash flow from financing activities	(83.7)	276.1	(359.8)	<(100.0)%
<b>Net increase / (decrease) in cash</b>	<b>(5.9)</b>	<b>37.7</b>	<b>(43.6)</b>	<b>&lt;(100.0)%</b>
Effect of movements in exchange rates on cash held	(1.0)	(2.1)	1.1	(52.4%)
Cash as of beginning of the period	75.0	39.5	35.5	89.9%
<b>Cash as of end of the period</b>	<b>68.1</b>	<b>75.0</b>	<b>(6.9)</b>	<b>(9.2%)</b>

## FREE CASH FLOW (FCF)

Free cash flow (FCF) is defined as the total of cash flow from operating and investing activities. The following table sets out the composition of FCF.

<b>Free cash flow</b>		T_010		
		Year ended Sept 30,		
IN € MILLIONS	2017	2016	Change	% change
Cash flow from operating activities	121.9	110.4	11.5	10.4%
Cash flow from investing activities	(44.1)	(348.8)	304.7	(87.4)%
<b>Free cash flow</b>	<b>77.8</b>	<b>(238.4)</b>	<b>316.2</b>	<b>&lt;(100.0)%</b>

## ADJUSTED FREE CASH FLOW

Excluding the cash outflow of (302.5) million for the acquisition of ACE, Hahn Gasferdern, Fabreeka and Tech Products in June 2016, adjusted free cash flow increased from €57.3 million in fiscal 2016 to €77.8 million in fiscal 2017. See the following table.

<b>Adjusted FCF</b>		T_011		
		Year ended Sept 30,		
IN € MILLIONS	2017	2016	Change	% change
Cash flows from operating activities	121.9	110.4	11.5	10.4%
Cash flows from investing activities before acquisitions	(44.1)	(53.1)	9.0	(16.9)%
<b>Adjusted FCF <sup>1)</sup></b>	<b>77.8</b>	<b>57.3</b>	<b>20.5</b>	<b>35.8%</b>

<sup>1)</sup> Adjusted FCF = FCF before acquisitions

## NET LEVERAGE RATIO

The net leverage ratio is defined as net financial debt divided by adjusted EBITDA.

Net financial debt is the nominal amount of financial debt, i.e. current and non-current financial liabilities, less cash and cash equivalents. Adjusted EBITDA is defined as adjusted EBIT before depreciation and amortization.

The net leverage ratio is presented because we believe it is a useful indicator to evaluate the Group's debt leverage and financing structure.

The net leverage ratio decreased from 2.5x in fiscal 2016 to 1.5x in fiscal 2017. See the following table.

### Net leverage ratio

T\_012

IN € MILLIONS	Year ended Sept 30,		Change	% change
	2017	2016		
Financial debt	342.5	405.0	(62.5)	(15.4%)
Cash and cash equivalents	(68.1)	(75.0)	6.9	(9.2%)
Net financial debt	274.4	330.0	(55.6)	(16.8%)
Adjusted EBITDA	179.5	133.3	46.2	34.7%
<b>Net leverage ratio</b>	<b>1.5x</b>	<b>2.5x</b>		



## STATUTORY RESULTS OF OPERATIONS AND FINANCIAL POSITION OF STABILUS S. A.

For the statutory annual accounts of Stabilus S. A., please refer to Chapter D.

### Results of operations

The Company's income results from services provided to Stabilus Group entities based on service-level-agreements in the amount of €3.5 million (PY: €12.9 million) and income from affiliate undertakings of €47.2 million (PY: €0 million), which relates to the dividend distribution of Servus III (Gibraltar) Limited.

Other external expenses decreased from €19.0 million in fiscal 2016 to €2.1 million in fiscal 2017 basically related to one-off consulting fees incurred in fiscal 2016.

Value adjustments in respect of financial assets were recorded in the amount of €17.2 million (PY: €0.1 million) which resulted from the merger of interim holdings in the course of the simplification of the Group's legal structure.

The profit for fiscal 2017 amounted to €29.9 million (PY: loss of €7.8 million).

### Financial position

Total assets increased from €623.3 million as of September 30, 2016 to €629.8 million as of September 30, 2017.

Fixed assets essentially comprise shares in affiliated undertakings which increased from €461.7 million as of September 30, 2016 to €628.4 million as of September 30, 2017. This is in substance due to a capital increase in Stable II S.à r. l. amounting to €149.6 million.

Current assets mainly comprise receivables from other debtors amounting to €0.5 million (PY: €0.2 million) and receivables from affiliated undertakings. These receivables decreased from €160.6 million as of September 30, 2016 to €0.2 million as of September 30, 2017 due to the capital increase in Stable II S.à r. l.

The Company's capital and reserves increased from €602.4 million as of September 30, 2016 to €619.9 million as of September 30, 2017 due to the profit for the period amounting to €29.9 million which is partially offset by the dividend payment of €12.4 million.

## RISKS AND OPPORTUNITIES

### Risk management and control over financial reporting in the Stabilus Group

The Company considers Risk Management (RM) to be a key part of effective management and internal control. The Company strives for effective RM and financial navigation to safeguard the assets of the Company and to proactively support the Company's strategic and compliance initiatives. The goal of RM is to help the Company to operate more effectively in a dynamic environment by providing a framework for a systematic approach to risk management and exploring opportunities with an acceptable level of risk. The Supervisory Board and the Management Board regularly discuss the operational and financial results as well as the related risks.

Risk Management covers financial, strategic, compliance as well as operational aspects. Operational risk is the risk of direct or indirect loss arising from a wide variety of causes associated with the Group's processes, personnel, technology and infrastructure, and from external factors other than credit, market and liquidity risks such as those arising from legal and regulatory requirements and generally accepted standards of corporate behavior. These operational risks arise from all of the Group's operations. The Group's objective is to manage operational risk in a way to balance the avoidance of financial losses and damage to the Group's reputation with overall cost effectiveness, as well as avoiding control procedures that restrict initiative and creativity. The Company's policy on managing financial risks seeks to ensure effective liquidity and cash flow management and protection of Group equity capital against financial risks. As part of its evolution, the Company implements continuous improvements in its risk management and internal control system.

Our accounting control system is designed to ensure all business transactions are correctly and promptly accounted for and that reliable data on the Company's financial situation is available. It ensures compliance with legal stipulations, accounting standards and accounting rules. By separating financial functions and through ongoing review, we ensure that potential errors are identified on a timely basis and accounting standards are complied with.

Our internal control system is an integral component of the risk management. The purpose of our internal control system for accounting and reporting is to ensure its compliance with legal stipulations, the principles of proper accounting, the rules on the International Financial Reporting Standards as adopted by the EU and with Group standards. In addition, we perform assessments to help identify and minimize any risk with a direct influence on our financial reporting. We monitor changes in accounting standards and enlist the advice of external experts to reduce the risk of accounting misstatements in complex issues.

The Company and individual entity financial statements are subject to external audits which act as an independent check and monitoring mechanism of the accounting system and its output. The principal risks that could have a material impact on the Group are set out in the Note 32 of the Consolidated Financial Statements and are summarized below.

## Risks and opportunities related to the markets in which we operate

We are exposed to risks and opportunities associated with the performance of the global economy and the performance of the economy in the jurisdictions in which we operate.

Due to our global presence, we are exposed to substantial risks and opportunities associated with the performance of the global economy. In general, demand for our products is dependent on the demand for automotive products as well as for commercial vehicles, agricultural machinery, medical equipment, renewable energy (in particular solar, wind), aerospace, marine and furniture components, which in turn is directly related to the strength of the global economy. Therefore, our financial performance has been influenced, and will continue to be influenced, to a significant extent, by the general state and the performance of the global economy.

Although the global economy has recovered a lot from the severe downturn in 2008 and 2009, the recent volatility of the financial markets and also the slower than expected economic growth in Asia show that there can be no assurance that any recovery is sustainable or that there will be no recurrence of the global financial and economic crisis or similar adverse market conditions.

Stabilus manages these risks and opportunities by operating in different regions and markets for local and global customers.

## WE OPERATE IN CYCLICAL INDUSTRIES

Our business is characterized by high fixed costs. Should our facilities be underutilized, this could result in idle capacity costs, write-offs of inventories and losses on products due to falling average sale prices. Furthermore, falling production volumes cause declines in revenue and earnings. On the other hand, our facilities might have insufficient capacity to meet customer demand if the markets in which we are active grow faster than we have anticipated.

Our automotive business, from which we generated 64% of our revenue in the fiscal year ended September 30, 2017, sells its products primarily to automotive original equipment manufacturers ("OEMs") in the automotive industry. These sales are cyclical and depend, among other things, on general economic conditions as well as on consumer spending and preferences, which can be affected by a number of factors, including employment, consumer confidence and income, energy costs, interest rate levels and the availability of consumer financing. Given the variety of such economic parameters influencing the global automotive demand, the volume of automotive production has historically been, and will continue to be, characterized by a high level of fluctuation, making it difficult for us to accurately predict demand levels for our products aimed at automotive OEMs.

We generated, in the aggregate, 36% of our revenue in the fiscal year ended September 30, 2017, from sales to our industrial customers. We sell our products to customers in diverse industries, including agricultural machines, renewable energy (in particular solar, wind), railway, aircraft applications, commercial vehicles, marine applications, furniture, health care and production equipment. These sales depend on the industrial production level in general as well as on the development of new products and technologies by our customers, which include our products as component parts. Stabilus manages these opportunities and risks by operating in different regions and markets for the local and global customers.

The business environment in which we operate is characterized by strong competition, which affects some of our products and markets, which could reduce our revenue or put continued pressure on our sales prices.

The markets in which we operate are competitive and have been characterized by changes in market penetration, increased price competition, the development and introduction of new products, product designs and technologies by significant existing and new competitors. The majority of gas springs and electromechanical lifting and closing systems manufactured globally are used for either automotive, industrial or commercial furniture applications, which are core markets for us. Our competitors are typically regional companies and our competition with them is generally on a regional scale. We compete primarily on the basis of price, quality, timeliness of delivery and design as well as the ability to provide engineering support and service on a global basis. Should we fail to secure the quality of our products and the reliability of our supply in the future, then more and more of our customers could decide to procure products from our competitors.

Our efforts to expand in certain markets are subject to a variety of business, economic, legal and political risks.

We manufacture our products in several countries and we market and sell our products worldwide. We are actively operating and expanding our operations in various markets, with a focus on the rapidly growing and emerging markets in the Asia / Pacific region, where we have production plants in China and South Korea, operate a wide network of representative sales offices and employ our own sales force and distribution network. We plan to expand our Asian production capacities to meet growth expectations and supplement demand with our other regional productions as needed.

Potential social, political, legal, and economic instability may pose significant risks to our ability to conduct our business and expand our activities in certain markets. Inherent in our international operations is the risk that any number of the following circumstances could affect our operations: underdeveloped infrastructure; lack of qualified management or adequately trained personnel; currency exchange controls, exchange rate fluctuations and devaluations; changes in local economic conditions; governmental restrictions on foreign investment, transfer or repatriation of funds; protectionist trade measures, such as anti-dumping measures, duties, tariffs or embargoes; prohibitions or restrictions on acquisitions or joint

ventures; changes in laws or regulations and unpredictable or unlawful government actions; the difficulty of enforcing agreements and collecting receivables through foreign legal systems; variations in protection of intellectual property and other legal rights; potential nationalization of enterprises or other expropriations; and political or social unrest or acts of sabotage or terrorism. As personnel costs have a significant effect on our business, we are also exposed to the risks of labor cost inflation and limited employment contract flexibility in the countries in which our production facilities are located and where we have sales personnel. Any of these risks could have a material adverse effect on our business, financial condition and results of operations.

#### **WE ARE EXPOSED TO OPPORTUNITIES AND RISKS ASSOCIATED WITH MARKET TRENDS AND DEVELOPMENTS**

There can be no assurance that (i) we will be successful in developing new products or systems or in bringing them to market in a timely manner, or at all; (ii) products or technologies developed by others will not render our offerings obsolete or non-competitive; (iii) our customers will not substitute our products with competing products or alternate technologies (such as third arm systems, hydraulic drives or hinge / direct drives); (iv) the market will accept our innovations; (v) our competitors will not be able to produce our non-patented products at lower costs than we can; and (vi) we will be able to fully adjust our cost structure in the event of contraction of demand.

The Company develops appropriate strategies as a response to these or similar market trends and to enhance existing products, develop new products or keep pace with developing technology, to counter loss of growth opportunities, pressure on margins or the loss of existing customers. We devote resources to the pursuit of new technologies and products. In addition, technological advances and wider market acceptance of our Powerise® automatic drive systems (or the development and wider market acceptance of similar automatic lid drive systems by our competitors) could result in cannibalization of our gas spring applications.

## Risks and opportunities related to our business

We are exposed to fluctuations in prices of prefabricated materials and components.

We procure large quantities of prefabricated materials and components from third-party suppliers. The prices of prefabricated materials, components and manufacturing services we purchase from our suppliers depend on a number of factors, including to a limited extent the development of prices of raw materials used in these products, such as steel, copper, rubber and water, as well as energy, which have been volatile in the past.

So far, this has not resulted in a general increase in the cost of prefabricated materials and components we procure for the manufacture of our products. However, it cannot be excluded that this volatility may result in a cost increase in the future. If we are not able to compensate for or pass on our cost increases to customers, such price increases could have a material adverse impact on our financial results. Even to the extent that we are successful in compensating for or passing on our increased costs to our customers by increasing prices on new products, the positive effects of such price increases may not occur in the periods in which the additional expenses have been incurred, but in later periods. If costs of raw materials and energy rise, and if we are not able to undertake cost saving measures elsewhere in our operations or increase to an adequate level the selling prices of our products, we will not be able to compensate such cost increases, which could have a material adverse effect on our business, financial condition and results of operations. The long-term increase of our costs (and resultant increase in the price of our products) may also negatively impact demand for our products.

Our future business success depends on our ability to maintain the high quality of our products and processes. For customers, one of the determining factors in purchasing our components and systems is the high quality of our products and manufacturing processes. A decrease in the actual and perceived quality of these products and processes could damage our image and reputation as well as those of our products. Any errors or delays caused by mistakes or miscalculations in our project management could negatively affect our customers' own production processes, resulting in reputational damage to us as supplier as well as to the affected customer as manufacturer. In addition, defective products could result in loss of sales, loss of customers and loss of market acceptance.

## LEGAL, TAXATION AND ENVIRONMENTAL RISKS AND OPPORTUNITIES

We are exposed to warranty and product liability claims.

As a manufacturer, we are subject to product liability lawsuits and other proceedings alleging violations of due care, violation of warranty obligations, treatment errors, safety provisions and claims arising from breaches of contract (like delivery delays), recall actions or fines imposed by government or regulatory authorities in relation to our products. Any such lawsuits, proceedings and other claims could result in increased costs for us. Additionally, authorities could prohibit the future sale of our products, particularly in cases of safety concerns. The aforementioned scenarios could result in loss of market acceptance, loss of revenue and loss of customers, in particular against the background that many of our products are components which often have a major impact on the overall safety, durability and performance of our customers' end-product.

The risks arising from such warranty and product liability lawsuits, proceedings and other claims are insured as we consider economically reasonable, but the insurance coverage could prove insufficient in individual cases. Any major defect in one of our products could also have a material adverse effect on our reputation and market perception, which in turn could have a significant adverse effect on our revenue and results of operations.

In addition, vehicle manufacturers are increasingly requiring a contribution from, or indemnity by, their suppliers for potential product liability, warranty and recall claims and we have been subject to continuing efforts by our customers to change contract terms and conditions concerning warranty and recall participation.

Furthermore, we manufacture many products pursuant to OEM customer specifications and quality requirements. If the products manufactured and delivered by us are deemed not to be fit for use by our OEM customers at the agreed date of delivery, production of the relevant products is generally discontinued until the cause of the product defect has been identified and remedied. Furthermore, our OEM customers could potentially bring claims for damages on the basis of breach of contract, even if the cause of the defect is remedied at a later point in time. In addition, failure to perform with respect to quality requirements could negatively affect the market acceptance of our other products and our market reputation in various market segments.

We are and may become party to certain disadvantageous contracts pursuant to which we are required to sell certain products at a loss or to agree to broad indemnities. For example, we may enter into a contract at an agreed price and production costs may end up exceeding what was assumed in the development phase. If the assumptions on which we rely in contract negotiations turn out to be inaccurate, this could have an adverse effect on our revenue and results of operations.

We are exposed to certain risks and opportunities with regards to our intellectual property, its validity and the intellectual property of third parties.

Our products and services are highly dependent upon our technological know-how and the scope and limitations of our proprietary rights therein. We have obtained or have applied for a number of intellectual property rights, which can be difficult, lengthy and expensive to procure. Furthermore, patents may not provide us with meaningful protection or a commercial advantage. In addition, where we incorporate an individual customer's input to create a product that responds to a particular need, we face the risk that such customer will claim ownership rights in the associated intellectual property.

Our competitors, suppliers, customers and other third parties also submit a large number of intellectual property protection applications. Such other parties could hold effective and enforceable intellectual property rights to certain processes, methods or applications and consequently could assert infringement claims (including illegitimate ones) against us.

A major part of our know-how is not patented and cannot be protected through intellectual property rights. Consequently, there is a risk that third parties, in particular competitors, may utilize our know-how without incurring any expenses of their own. Our intellectual property is often discovered by and during the course of our employees' employment. As a result, there is a risk that we have failed or will fail to properly utilize inventions of our employees. Present or former employees who made or make employee inventions might continue to be the owners of the valuable rights to inventions if we fail to claim the invention in a timely manner.

The realization of any of these risks could give rise to intellectual property claims against us. Such claims, if successful, could require us to cease manufacturing, using or marketing the relevant technologies or products in certain countries or be forced to make changes to manufacturing processes or products. In addition, we could be liable

to pay compensation or damages for infringements or could be forced to purchase licenses to make use of technology from third parties. This could have a material adverse effect on our business, financial condition and results of operations.

We are subject to risks from legal, administrative and arbitration proceedings.

We are involved in a number of legal and administrative proceedings related to products, patents and other matters incidental to our business and could become involved in additional legal, administrative and arbitration proceedings in the future. These proceedings or potential proceedings could involve, in particular in the United States, substantial claims for damages or other payments. Based on a judgment or a settlement agreement, we could be obligated to pay substantial damages. Our litigation costs and those of third parties could also be significant.

Due to our high market share, we may be exposed to legal risks regarding anti-competition fines and related damage claims.

Our market share in most of the markets in which we operate is high, which may induce competition authorities to initiate proceedings or third parties to file claims against us alleging violation of competition laws. A successful anti-competition challenge could adversely affect us in a variety of ways. For example, it could result in the imposition of fines by one or more authorities and/or in third parties (such as competitors or customers) initiating civil litigation claiming damages caused by anti-competitive practices. In addition, anti-competitive behavior may give rise to reputational risk to us. The realization of this risk could have a material effect on our business, financial condition and results of operations.

Interest carry-forwards may be forfeited in part or in full as a result of subsequent share sales.

Some Stabilus subsidiaries have significant interest carry-forwards as a result of the application of the statutory interest ceiling rules that limit the deduction of net interest expenses for tax purposes. The interest carry-forward may be deducted to the extent that in subsequent assessment periods the then current interest expenses do not reach the interest ceiling applicable to the relevant assessment period, and, thus, reduce the tax payable by the relevant subsidiary.



However, the interest carry-forward will be forfeited on a pro rata base or in full if more than a defined percentage of the shares in entities are directly or indirectly transferred to a new shareholder, persons related to such shareholder or a group of shareholders acting in the same interest, or in case of similar transactions (such as a capital increase) that result in a change of the shareholder structure. Such forfeiture would increase the tax payable by the relevant subsidiary if without the forfeiture the interest carry-forward could have been used in part or in full.

We could be held liable for soil, water or groundwater contamination or for risks related to hazardous materials.

Many of the sites at which we operate have been used for industrial purposes for many years, leading to risks of contamination and the resulting site restoration obligations. In addition, we could be held responsible for the remediation of areas adjacent to our sites if these areas were potentially contaminated due to our activities. Groundwater contamination was discovered at a site in Colmar, Pennsylvania operated by us from 1979 to 1998. In June 2012, the U.S. Environmental Protection Agency ("EPA") issued an administrative order against our U.S. subsidiary and determined requirements in respect of the remedy and the remedy cost. Our subsidiary, together with the other responsible parties, is requested to reimburse the EPA for past and current expenses and to bear the remediation costs. If additional contamination is discovered in the future, the competent authorities could assert further claims against us, as the owner or tenant of the affected plots, for the examination or remediation of such soil or groundwater contamination, or order us to dispose of or treat contaminated soil excavated in the course of construction. We could also be required to indemnify the owners of plots leased by us or of other properties, if the authorities were to pursue claims against the relevant owner of the property and if we caused the contamination. Costs typically incurred in connection with such claims are generally difficult to predict. Also, if any contamination were to become the subject of a more intense public discussion, there is a risk that our reputation or relations with our customers could be harmed.

Furthermore, at some of the sites at which we operate, or at which we operated in the past, small quantities of hazardous materials were used in the past, such as asbestos-containing building materials used for heat insulation. While we consider it unlikely, it cannot be ruled out that the health and safety of third parties (such as former employees) may have been affected due to the use of such hazardous materials or that other claims may be asserted and we could

therefore be exposed to related damage claims in the future. Even if we have contractually excluded or limited our liability in connection with the sale of such properties, we could be held responsible for currently unknown contamination on properties which we previously owned or used.

The in-house legal department monitors these risks continuously and reports regularly to Group management and the Supervisory Board.

## Risks and opportunities related to our capital structure

Due to our high level of debt we face potential liquidity risks.

Our cash from operating activities, current cash resources and existing sources of external financing could be insufficient to meet our further capital needs, especially if our sales decrease significantly. Disruptions in the financial markets, including the bankruptcy, insolvency or restructuring of a number of financial institutions, and restricted availability of liquidity could adversely impact the availability and cost of additional financing for us and could adversely affect the availability of financing already arranged or committed. Our liquidity could also be adversely impacted if our suppliers tighten terms of payment as the result of any decline in our financial condition or if our customers were to extend their normal payment terms.

Stabilus has set an appropriate liquidity risk management framework for the management of the Group's short, medium and long-term funding and liquidity requirements. The Group manages liquidity risk by regular reviews, maintaining certain cash reserves, as well as open credit lines.

We are exposed to risks and opportunities associated with changes in currency exchange rates.

We operate worldwide and are therefore exposed to financial risks that arise from changes in exchange rates. Currency exchange fluctuations could cause losses if assets denominated in currencies with a falling exchange rate lose value, while at the same time liabilities denominated in currencies with a rising exchange rate appreciate. In addition, fluctuations in foreign exchange rates could enhance or minimize fluctuations in the prices of materials, since we purchase a considerable part of the prefabricated materials

which we source from foreign currencies. As a result of these factors, fluctuations in exchange rates could affect our results of operations. External and internal transactions involving the delivery of products and services to and / or by third parties result in cash inflows and outflows which are denominated in currencies other than the functional currency of our respective Group member. Among other factors, we are particularly exposed to fluctuations of net inflows in U.S. dollar (surplus) and net outflows in Romanian leu (demand). To the extent that cash outflows are not offset by cash inflows resulting from operational business in such currency, the remaining net foreign currency exposure is not hedged as of September 30, 2017.

Although we may enter into certain hedging arrangements in the future, there can be no assurance that hedging will be available or continue to be available on commercially reasonable terms. In addition, if we were to use any hedging transactions in the future in the form of derivative financial instruments, such transactions may result in mark-to-market losses. In addition, we are exposed to foreign exchange risks arising from internal loan agreements, which result from cash inflows and outflows in currencies other than the functional currency of our respective Group member. As of the September 30, 2017, these foreign exchange risks are not hedged against by using derivative financial instruments. Our net foreign investments are generally not hedged against exchange rate fluctuations. In addition, a number of our consolidated companies report their results in currencies other than the Euro, which requires us to convert the relevant items into Euro when preparing our consolidated financial statements. Translation risks are generally not hedged.

The Management Board does not see any individual or aggregate risk that could endanger the future of Stabilus in any material way.

## CORPORATE GOVERNANCE

As a Luxembourg société anonyme, the Company is subject to the corporate governance regime as set forth in particular in the law of August 10, 1915 on commercial companies. As a Company whose shares are listed on a regulated market, the Company is further subject to the law of May 24, 2011 on the exercise of certain shareholder rights in listed companies.

As a Luxembourg société anonyme whose shares are exclusively listed on a regulated market in Germany, the Company is not required to adhere to the Luxembourg corporate governance regime applicable to companies that are traded in Luxembourg or to the German corporate governance regime applicable to stock corporations organized in Germany. The Company has decided to set up own corporate governance rules as described in the following paragraphs rather than to confirm such corporate governance regimes in order to build up a corporate governance structure which meets the specific needs and interests of the Company.

The internal control systems and risk management for the establishment of financial information is described in the section "Risk management and control over financial reporting in the Stabilus Group".

According to the Articles of Incorporation of the Company, the Management Board must be composed of at least two Management Board members, and the Supervisory Board must be composed of at least three Supervisory Board members. The Supervisory Board has set up the following committees in accordance with the Articles of Incorporation: Audit Committee and Remuneration Committee. The Audit Committee is responsible for the consideration and evaluation of the auditing and accounting policies and its financial controls and systems. The Remuneration Committee is responsible for making recommendations to the Supervisory Board and the Management Board on the terms of appointment and the benefits of the managers of the Company. Further details on the composition and purpose of these committees and of the Management Board and the Supervisory Board is described in the section "Management and Supervisory Board of Stabilus S. A.".

The Annual General Meeting shall be held at such time as specified by the Management Board and the Supervisory Board in the convening notice. The Management Board and Supervisory Board may convene extraordinary general meetings as often as the Company's interests so require. An extraordinary general shareholders' meeting must be convened upon the request of one or more shareholders who together represent at least one tenth of the Company's share capital.

Each share entitles the holder to one vote. The right of a shareholder to participate in a General Meeting and to exercise the voting rights attached to his shares are determined with respect to the shares held by such shareholder the 14th day before the General Meeting. Each shareholder can exercise his voting rights in person, through a proxyholder or in writing (if provided for in the relevant convening notice).

The information required by Article 10.1 of Directive 2004/25/EC on takeover bids which has been implemented by Article 11 of the Luxembourg Law on Takeovers of May 19, 2006 (the "Law on Takeovers") is set forth here below under "Disclosure Regarding Article 11 of the Law on Takeovers of May 19, 2006".

#### **DISCLOSURES PURSUANT TO ARTICLE 11 OF THE LUXEMBOURG LAW ON TAKEOVERS OF MAY 19, 2006**

- A) For information regarding the structure of capital, reference is made to Note 21 of the Consolidated Financial Statements.
- B) The Articles of Incorporation of the Company do not contain any restrictions on the transfer of shares of the Company.
- C) According to the voting rights notifications received in fiscal year 2017, the following shareholders held more than 5% of total voting rights attached to Stabilus shares as of September 30, 2017: Marathon Asset Management LLP, London, UK (direct: 1,745,599 voting rights attached to shares or 7.07% of total voting rights, indirect: 1,459,614 voting rights attached to shares or 5.91% of total voting rights) and BlackRock, Inc., Wilmington, DE, USA (indirect: 1,233,141 voting rights attached to shares or 4.99% of total voting rights; 2,096 voting rights or 0.01% of total voting rights, through financial instruments according to Art. 13(1)(a) of Directive 2004/109/EC and 668,013 voting rights or 2.70% of total voting rights, according to Art. 13(1)(b) of Directive 2004/109/EC.
- D) The control rights of any shares issued in connection with employee share schemes are exercised directly by the respective employees.
- E) The Articles of Incorporation of the Company do not contain any restrictions on voting rights.
- F) There are no agreements with shareholders which are known to the Company and may result in restrictions on the transfer of securities or voting rights within the meaning of Directive 2004/109/EC (Transparency Directive).
- G) Rules governing the appointment and replacement of Management Board members and the amendment of the Articles of Incorporation:
- The Management Board members are appointed by the Supervisory Board by the majority of the votes of the members present or represented (abstention or non-participation being taken into account as a vote against the appointment), or in the case of a vacancy, by way of a decision of the remaining Management Board members for the period until the next Supervisory Board Meeting.
  - Management Board members serve for the following terms: Chief Executive Officer four years, Chief Financial Officer three years and other Board members one year. Management Board members are eligible for re-appointment.
  - Management Board members may be removed at any time with or without cause by the Supervisory Board by a simple majority of the votes.
  - Resolutions to amend the Articles of Incorporation may be adopted by a majority of two thirds of the votes validly cast, without counting the abstentions, if the quorum of half of the share capital is met. If the quorum requirement of half of the share capital of the Company is not met at the Annual General Meeting, then the shareholders may be re-convened to a second General Meeting. No quorum is required in respect of such second General Meeting and the resolutions are adopted by a supermajority of two-thirds of the votes validly cast, without counting the abstentions.
- H) Powers of the Management Board:
- The Company is managed by a Management Board under the supervision of the Supervisory Board.
  - The Management Board is vested with the broadest powers to perform or cause to be performed any actions necessary or useful in connection with the purpose of the Company.
  - All powers not expressly reserved by the Luxembourg Companies Act or by the Articles of Incorporation to the General

Meeting or the Supervisory Board fall within the authority of the Management Board.

- Certain transactions and measures are subject to the prior approval of the Supervisory Board on the terms set out in the Articles of Incorporation.
  - The Management Board may appoint one or more persons, who may be a shareholder or not, or who may be a member of the Management Board or not, to the exclusion of any member of the Supervisory Board, who shall have full authority to act on behalf of the Company in all matters pertaining to the daily management and affairs of the Company.
  - The Management Board is also authorized to appoint a person, either a director or not, to the exclusion of any member of the Supervisory Board, for the purposes of performing specific functions at every level within the Company.
  - The Management Board may also appoint committees and sub-committees in order to deal with specific tasks, to advise the Management Board or to make recommendations to the Management Board and/or, as the case may be, the General Meeting, the members of which may be selected either from among the members of the Management Board or not, to the exclusion of any member of the Supervisory Board.
- The Management Board does not have currently any authority to issue shares in the Company under the Articles of Incorporation.
  - The Management Board does not have currently any authority to buy back shares under the Articles of Incorporation or a buy-back program.
- I) There are no significant agreements to which the Company is party and which take effect, alter or terminate upon a change of control of the Company following a takeover bid.
- J) There are no agreements between the Company and its Management Board members or employees providing for compensation if they resign or are made redundant without valid reason or if their employment ceases because of a takeover bid.

## SUBSEQUENT EVENTS

As of December 13, 2017, there were no further events or developments that could have materially affected the measurement and presentation of Group's assets and liabilities as of September 30, 2017.

## OUTLOOK

As last year the global economic environment continues to remain challenging, but the IMF in substance predicts improved growth rates in contrast to last year's expected stagnation in several countries. The IMF essentially expects stronger growth rates in nearly all country groups, as reflected in the October 2017 World Economic Outlook. The overall growth rate is projected to be 3.6% in 2017 and 3.7% in 2018, compared to a growth rate of 3.2% in 2016. This is driven by increased projected growth rates in advanced economies, especially in the Euro Area, as well as strong projected growth rates in China and some developing economies and emerging markets.

IHS Markit, an information services and automotive forecasts provider, expects the worldwide production of light vehicles to increase to around 95.1 million units in calendar year 2017 (+2.2% y / y) and around 96.6 million units in calendar year 2018 (+1.6% y / y). See table T\_002 on page 40 for further details.

Considering our product markets we aim to outperform the growth rate of the worldwide light-vehicle production (+2.2%) and the growth rate of the global economy (GDP growth: 3.6% in 2017) respectively.

We intend to grow our automotive and industrial business in all operating segments, i.e. in Europe, NAFTA as well as Asia / Pacific and RoW. At constant exchange rates, i.e. assuming an average exchange rate of 1.10 \$ / € for FY2018, the revenue is expected to grow by approximately 7.1%. In Europe and NAFTA we estimate a revenue growth rate of around 5% to 7%. As a result of our initiatives in China, we aim to grow in Asia / Pacific and RoW with a double digit revenue growth rate.

Assuming an average currency rate of 1.15 \$ / €, we expect total revenue of approximately €960 million or a revenue growth of around 5.5% and an adjusted EBIT margin of around 15.5% for FY2018. The revenue growth at constant rates, i.e. based on the average rate from FY2017 of 1.10 \$ / €, is estimated to be around 7.1%.

A five dollar cent lower currency rate assumption (1.10 \$ / €) would lead to a €15 million higher revenue expectation (approximately €975 million). A five dollar cent higher currency rate assumption (1.20 \$ / €) would lead to a €15 million lower revenue expectation (approximately €945 million).



CONSOLIDATED  
**FINANCIAL  
STATEMENTS**

CHAPTER

**C**

61 - 138

# CONSOLIDATED FINANCIAL STATEMENTS

for the fiscal year ended September 30, 2017

63	<b>CONSOLIDATED STATEMENT OF COMPREHENSIVE INCOME</b>	101	20 Cash and cash equivalents
64	<b>CONSOLIDATED STATEMENT OF FINANCIAL POSITION</b>	101	21 Equity
66	<b>CONSOLIDATED STATEMENT OF CHANGES IN EQUITY</b>	103	22 Financial liabilities
67	<b>CONSOLIDATED STATEMENT OF CASH FLOWS</b>	104	23 Other financial liabilities
68	<b>NOTES TO THE CONSOLIDATED FINANCIAL STATEMENTS</b>	104	24 Provisions
68	1 General Information	107	25 Pension plans and similar obligations
69	2 Basis for presentation	110	26 Trade accounts payable
78	3 Accounting policies	110	27 Current tax liabilities
86	4 Revenue	111	28 Other liabilities
87	5 Cost of sales, research and development, selling and administrative expenses	111	29 Leasing
88	6 Other income	113	30 Contingent liabilities and other financial commitments
88	7 Other expenses	114	31 Financial instruments
89	8 Finance income	116	32 Risk reporting
89	9 Finance costs	119	33 Capital management
90	10 Income tax expense	120	34 Notes to the consolidated statement of cash flows
93	11 Earnings per share	120	35 Segment reporting
94	12 Property, plant and equipment	124	36 Share-based payments
95	13 Goodwill	128	37 Auditor's fees
97	14 Other intangible assets	128	38 Related party relationships
98	15 Other financial assets	129	39 Remuneration of key management personnel
99	16 Other assets	129	40 Subsequent events
99	17 Inventories	130	<b>RESPONSIBILITY STATEMENT</b>
100	18 Trade accounts receivable	131	<b>MANAGEMENT BOARD OF STABILUS S.A.</b>
100	19 Current tax assets	132	<b>SUPERVISORY BOARD OF STABILUS S.A.</b>
		133	<b>INDEPENDENT AUDITOR'S REPORT</b>

# CONSOLIDATED STATEMENT OF COMPREHENSIVE INCOME

for the fiscal year ended September 30, 2017

## Consolidated statement of comprehensive income

T\_013

IN € THOUSANDS	NOTE	Year ended Sept 30,	
		2017	2016
Revenue	4	910,016	737,501
Cost of sales	5	(637,164)	(547,700)
<b>Gross profit</b>		<b>272,852</b>	<b>189,801</b>
Research and development expenses	5	(38,194)	(26,590)
Selling expenses	5	(80,380)	(55,462)
Administrative expenses	5	(35,343)	(33,881)
Other income	6	12,765	12,074
Other expenses	7	(13,311)	(9,300)
<b>Profit from operating activities</b>		<b>118,389</b>	<b>76,644</b>
Finance income	8	22,323	2,556
Finance costs	9	(29,799)	(13,261)
<b>Profit / (loss) before income tax</b>		<b>110,913</b>	<b>65,938</b>
Income tax income / (expense)	10	(31,670)	(17,951)
<b>Profit / (loss) for the period</b>		<b>79,243</b>	<b>47,987</b>
thereof attributable to non-controlling interests		(12)	16
thereof attributable to shareholders of Stabilus	11	79,255	47,971
<b>Other comprehensive income / (expense)</b>			
Foreign currency translation difference <sup>1)</sup>	21	3,328	(8,858)
Unrealized actuarial gains and losses <sup>2)</sup>	21	3,306	(5,490)
Cash flow hedges – effective portion of changes in fair value <sup>1)</sup>	21	–	6,798
Cash flow hedges – reclassified to profit or loss	21	–	(6,798)
<b>Other comprehensive income / (expense), net of taxes</b>		<b>6,634</b>	<b>(14,348)</b>
<b>Total comprehensive income / (expense) for the period</b>		<b>85,877</b>	<b>33,639</b>
thereof attributable to non-controlling interests		(12)	16
thereof attributable to shareholders of Stabilus		85,889	33,623
<b>Earnings per share (in €):</b>			
basic	11	3.21	2.21
diluted	11	3.21	2.21

<sup>1)</sup> Item that may be reclassified ('recycled') to profit and loss at a future point in time when specific conditions are met.

<sup>2)</sup> Item that will not be reclassified to profit and loss.

The accompanying Notes form an integral part of these Consolidated Financial Statements.

## CONSOLIDATED STATEMENT OF FINANCIAL POSITION

as of September 30, 2017

### Consolidated statement of financial position

T\_014

IN € THOUSANDS	NOTE	Sept 30, 2017	Sept 30, 2016
<b>Assets</b>			
Property, plant and equipment	12	169,659	167,569
Goodwill	13	194,184	197,457
Other intangible assets	14	268,911	295,815
Other assets	16	2,951	3,267
Deferred tax assets	10	12,083	7,743
<b>Total non-current assets</b>		<b>647,788</b>	<b>671,851</b>
Inventories	17	85,262	74,681
Trade accounts receivable	18	105,147	97,600
Current tax assets	19	5,802	1,160
Other financial assets	15	5,155	3,160
Other assets	16	12,718	13,923
Cash and cash equivalents	20	68,123	75,037
<b>Total current assets</b>		<b>282,207</b>	<b>265,561</b>
<b>Total assets</b>		<b>929,995</b>	<b>937,412</b>

**Consolidated statement of financial position**

T\_014

IN € THOUSANDS	NOTE	Sept 30, 2017	Sept 30, 2016
<b>Equity and liabilities</b>			
Issued capital	21	247	247
Capital reserves	21	225,848	225,848
Retained earnings	21	139,440	72,535
Other reserves	21	(29,198)	(35,832)
<b>Equity attributable to shareholders of Stabilus</b>		<b>336,337</b>	<b>262,798</b>
Non-controlling interests		43	94
<b>Total equity</b>		<b>336,380</b>	<b>262,892</b>
Financial liabilities	22	311,951	396,095
Other financial liabilities	23	1,830	2,314
Provisions	24	3,771	3,781
Pension plans and similar obligations	25	53,236	58,738
Deferred tax liabilities	10	60,036	60,634
Other liabilities	28	–	879
<b>Total non-current liabilities</b>		<b>430,824</b>	<b>522,441</b>
Trade accounts payable	26	79,073	80,389
Financial liabilities	22	10,000	5,000
Other financial liabilities	23	9,613	9,399
Current tax liabilities	27	15,612	10,904
Provisions	24	33,061	30,898
Other liabilities	28	15,432	15,489
<b>Total current liabilities</b>		<b>162,791</b>	<b>152,079</b>
<b>Total liabilities</b>		<b>593,615</b>	<b>674,520</b>
<b>Total equity and liabilities</b>		<b>929,995</b>	<b>937,412</b>

The accompanying Notes form an integral part of these Consolidated Financial Statements.



## CONSOLIDATED STATEMENT OF CHANGES IN EQUITY

for the fiscal year ended September 30, 2017

### Consolidated statement of changes in equity

T\_015

IN € THOUSANDS	NOTE	Issued capital	Capital reserves	Retained earnings	Other reserves	Equity attributable to shareholders of Stabilus	Non- controlling interests	Total equity
<b>Balance as of Sept 30, 2015</b>		<b>207</b>	<b>73,091</b>	<b>24,871</b>	<b>(21,484)</b>	<b>76,685</b>	<b>24</b>	<b>76,709</b>
Profit / (loss) for the period		–	–	47,971	–	47,971	16	47,987
Other comprehensive income / (expense)	21	–	–	–	(14,348)	(14,348)	–	(14,348)
Total comprehensive income for the period		–	–	47,971	(14,348)	33,623	16	33,639
Dividends		–	–	–	–	–	(78)	(78)
Change in non-controlling interest		–	–	(307)	–	(307)	133	(174)
Capital increase		40	152,757	–	–	152,797	–	152,797
<b>Balance as of Sept 30, 2016</b>		<b>247</b>	<b>225,848</b>	<b>72,535</b>	<b>(35,832)</b>	<b>262,798</b>	<b>94</b>	<b>262,892</b>
Profit / (loss) for the period		–	–	79,255	–	79,255	(12)	79,243
Other comprehensive income / (expense)	21	–	–	–	6,634	6,634	–	6,634
Total comprehensive income for the period		–	–	79,255	6,634	85,889	(12)	85,877
Dividends	21	–	–	(12,350)	–	(12,350)	(54)	(12,404)
Receipts from non-controlling interest		–	–	–	–	–	15	15
<b>Balance as of Sept 30, 2017</b>		<b>247</b>	<b>225,848</b>	<b>139,440</b>	<b>(29,198)</b>	<b>336,337</b>	<b>43</b>	<b>336,380</b>

The accompanying Notes form an integral part of these Consolidated Financial Statements.

# CONSOLIDATED STATEMENT OF CASH FLOWS

for the fiscal year ended September 30, 2017

## Consolidated statement of cash flows

T\_016

IN € THOUSANDS	NOTE	Year ended Sept 30,	
		2017	2016 <sup>1)</sup>
Profit / (loss) for the period		79,243	47,987
Income tax expense		31,670	17,951
Net finance result	8/9	7,476	10,705
Interest received		230	88
Depreciation and amortization (incl. impairment losses)	12/14	61,102	49,285
Gains / losses from the disposal of assets		(49)	162
Changes in inventories		(10,581)	277
Changes in trade accounts receivable		(7,547)	(23,596)
Changes in trade accounts payable		(1,316)	7,615
Changes in other assets and liabilities		(7,716)	384
Changes in provisions		1,504	13,190
Income tax payments	34	(32,090)	(13,599)
<b>Cash flow from operating activities</b>		<b>121,926</b>	<b>110,449</b>
Proceeds from disposal of property, plant and equipment		980	543
Purchase of intangible assets	14	(11,552)	(13,783)
Purchase of property, plant and equipment	12	(33,497)	(39,895)
Acquisition of assets and liabilities within the business combination, net of cash acquired		–	(302,478)
Proceeds from currency hedging related to the business combination		–	6,798
<b>Cash flow from investing activities</b>		<b>(44,069)</b>	<b>(348,815)</b>
Receipts from contributions of equity		–	159,070
Receipts under senior facilities		–	570,000
Receipts from non-controlling interests		15	–
Payments for redemption of senior facilities		(62,500)	(432,500)
Payments for finance leases	29	(547)	(471)
Payments of transaction costs		–	(12,788)
Dividends paid	21	(12,350)	–
Dividends paid to non-controlling interests		(54)	(78)
Payment for acquisition of non-controlling interests		–	(174)
Payments for interest	34	(8,280)	(6,984)
<b>Cash flow from financing activities</b>		<b>(83,716)</b>	<b>276,075</b>
<b>Net increase / (decrease) in cash and cash equivalents</b>		<b>(5,859)</b>	<b>37,708</b>
Effect of movements in exchange rates on cash held		(1,055)	(2,145)
Cash and cash equivalents as of beginning of the period		75,037	39,473
<b>Cash and cash equivalents as of end of the period</b>		<b>68,123</b>	<b>75,037</b>

<sup>1)</sup> The prior-year figures have been adjusted in accordance with the current structure. The accompanying Notes form an integral part of these Consolidated Financial Statements.

# NOTES TO THE CONSOLIDATED FINANCIAL STATEMENTS

as of and for the fiscal year ended September 30, 2017

## 1 General information

Stabilus S. A., Luxembourg, hereinafter also referred to as “Stabilus” or the “Company” is a public limited liability company (société anonyme) incorporated in Luxembourg and governed by Luxembourg law. The Company is registered with the Luxembourg Trade and Companies Register (Registre de Commerce et des Sociétés Luxembourg) under No. B0151589 and its registered office is located at 2, rue Albert Borschette, L-1246 Luxembourg, Grand Duchy of Luxembourg. The Company was founded under the name Servus HoldCo S.à r. l. on February 26, 2010.

The Company’s fiscal year is from October 1 to September 30 of the following year (twelve-month period). The consolidated financial statements of Stabilus S. A. include Stabilus and its subsidiaries (hereafter also referred to as “Stabilus Group” or the “Group”).

The Stabilus Group is a leading manufacturer of gas springs and dampers, as well as electric tailgate opening and closing equipment. The products are used in a wide range in automotive and industrial applications, as well as in the furniture industry. Typically the products are used to support the lifting and lowering or dampening of movements. As world market leader for gas springs, the Group ships to all key vehicle manufacturers. Various Tier 1 suppliers of the global car industry as well as large technical focused distributors further diversify the Group’s customer base.

The consolidated financial statements are prepared in euro (€) rounded to the nearest thousand. Due to rounding, numbers presented may not add up precisely to totals provided.

The consolidated financial statements of Stabilus and its subsidiaries have been prepared in accordance with International Financial Reporting Standards (IFRS), as adopted by the EU.

The consolidated financial statements were authorized for issue by the Management Board on December 13, 2017.

## **2** Basis for presentation

### **PREPARATION**

In the statement of financial position assets and liabilities are classified as non-current and current. They are reported as current if the remaining term is less than one year and as non-current if the remaining term is over one year. Deferred tax assets and liabilities, as well as provisions for defined benefit pension plans and similar obligations are reported as non-current. The consolidated statement of comprehensive income is presented using the cost of sales method.

### **MEASUREMENT**

The consolidated financial statements have been prepared on historical cost basis, except for certain items, that are measured at fair value, like derivative financial instruments. The exceptions are described below.

### **USE OF ESTIMATES AND JUDGMENTS**

The preparation of financial statements requires estimates that involve complex and subjective judgments and the use of assumptions for matters that are uncertain and are subject to change. Estimates can change from period to period and can have a material impact on financial positions, income and expenses. Management regularly reviews estimates and assumptions. These are updated if necessary.

#### **Impairment of non-financial assets**

Stabilus monitors whether there are indications that its non-financial assets may be impaired. Goodwill and development cost under construction are tested for impairment annually. Further tests are carried out if there are indications for impairment. Other non-financial assets are tested for impairment if there are indications that the carrying amount may not be recoverable. If the fair value less costs of disposal is calculated, management must estimate the expected future cash flows from the asset or the cash-generating unit and select an appropriate discount rate in order to determine the present value.

#### **Trade and other receivables**

The allowance for doubtful accounts requires management judgment and review of individual receivables based on individual customer creditworthiness, current economic trends and analysis of historical allowances. Please also refer to Note 18.

#### **Deferred tax assets**

The valuation of deferred tax assets is based on mid-term business plans of the entities carrying the deferred tax asset. The mid-term business plans range from three to five years and include various assumptions and estimates relating to the business development, strategic changes, cost optimization and business improvement and also general market and economic development. Deferred tax assets are recognized to the extent that sufficient taxable profit will be available for the utilization of the deductible temporary differences. Stabilus recognizes a valuation allowance for deferred tax assets when it is unlikely that sufficient future taxable profit will be available. Please also refer to Note 10.

### **Provisions**

Significant estimates are required in the determination of provisions related to pensions and other obligations, contract losses, warranty costs and legal proceedings. Please also refer to Notes 24 and 25.

### **RISKS AND UNCERTAINTIES**

The Group's net assets, financial position and results of operations are subject to risks and uncertainties. Actual results can vary from expectations due to changes in the overall economy, involvement of price-aggressive competitors, significant price changes for raw materials and overall purchase costs. Furthermore quality issues may result in significant costs for the Group. The Group financing is based on variable interest rates and is subject to risks and uncertainties due to the development of the Euribor and the net leverage level of the Company. The term of the loan agreement ends June 2022.

### **GOING CONCERN**

These consolidated financial statements have been prepared under the going concern assumption.

### **SCOPE OF CONSOLIDATION**

The consolidated financial statements include the financial statements of Stabilus S. A. and all subsidiaries, which are directly or indirectly controlled by Stabilus. Control exists if the Company has the decision-making power over the relevant activities of an entity and it participates in positive and negative variable returns from that entity and it can affect these returns by its decision-making power.

Non-controlling interests represent the portion of profit and loss and net assets not held by the Company. They are presented separately in the consolidated statement of comprehensive income and the consolidated statement of financial position.

The results of subsidiaries acquired or disposed of during the period are included in the consolidated statement of comprehensive income from the date of acquisition or until the date of disposal, as appropriate.

Next to Stabilus S. A., 38 (PY: 41) subsidiaries (see following list), are included in the consolidated financial statements as of September 30, 2017.



## Subsidiaries

T\_017

NAME OF THE COMPANY	Registered office of the entity	Interest and control held by	Holding in %	Consolidation method
Servus III (Gibraltar) Limited	Gibraltar	Stabilus S.A.	100.00%	Full
Blitz F10-neun GmbH i.L.	Koblenz, Germany	Stabilus S.A.	100.00%	Full
Stable II S.à r.l.	Luxembourg	Stabilus S.A.	100.00%	Full
Stable Beteiligungs GmbH	Koblenz, Germany	Stable II S.à r.l.	100.00%	Full
Stable HoldCo Inc.	Wilmington, USA	Stable Beteiligungs GmbH	50.00%	Full
		Stable II S.à r.l.	50.00%	
Stable HoldCo Australia Pty. Ltd.	Dingley, Australia	Stable II S.à r.l.	100.00%	Full
LinRot Holding AG i.L.	Zurich, Switzerland	Stable II S.à r.l.	100.00%	Full
Stabilus UK Ltd.	Banbury, United Kingdom	Stable Beteiligungs GmbH	100.00%	Full
Stable UK HoldCo Ltd.	Banbury, United Kingdom	Stabilus UK Ltd.	100.00%	Full
Stabilus GmbH	Koblenz, Germany	Stable Beteiligungs GmbH	100.00%	Full
Stabilus Powerise GmbH i.L.	Melle, Germany	LinRot Holding AG	100.00%	Full
Stabilus Pty. Ltd.	Dingley, Australia	Stable HoldCo Australia Pty. Ltd.	100.00%	Full
Stabilus Ltda.	Itajubá, Brazil	Stabilus GmbH	100.00%	Full
Stabilus Espana S.L.	Lezama, Spain	Stabilus GmbH	100.00%	Full
Stabilus Co. Ltd.	Busan, South Korea	Stabilus GmbH	100.00%	Full
Stabilus S.A. de C.V.	Ramos Arizpe, Mexico	Stabilus GmbH	99.9998%	Full
		Stabilus UK Ltd.	0.0002%	
Stabilus Inc.	Gastonia, USA	Stable HoldCo Inc.	100.00%	Full
Stabilus Limited	Auckland, New Zealand	Stabilus GmbH	80.00%	Full
Stabilus Japan Corp.	Yokohama, Japan	Stable Beteiligungs GmbH	100.00%	Full
Stabilus France S.à r.l.	Poissy, France	Stabilus GmbH	100.00%	Full
Stabilus Romania S.R.L.	Brasov, Romania	Stable Beteiligungs GmbH	3.01%	Full
		Stabilus GmbH	96.99%	
Stabilus (Jiangsu) Ltd.	Wujin, China	Stabilus GmbH	100.00%	Full
Stabilus Mechatronics Service Ltd.	Shanghai, China	Stabilus (Jiangsu) Ltd.	100.00%	Full
Orion Rent Immobiliare S.R.L.	Brasov, Romania	Stable Beteiligungs GmbH	98.00%	Full
		Stabilus UK Ltd.	2.00%	
Stabilus US Holding Corp.	Wilmington, USA	Stable II S.à r.l.	100.00%	Full
Stabilus Motion Controls GmbH	Langenfeld, Germany	Stable II S.à r.l.	100.00%	Full
Fabreeka Group Holdings, Inc.	Stoughton, USA	Stabilus US Holding Corp.	100.00%	Full
ACE Controls Inc.	Farmington Hills, USA	Stabilus US Holding Corp.	100.00%	Full
ACE Controls International Inc.	Farmington Hills, USA	Stabilus US Holding Corp.	100.00%	Full
Fabreeka International Holdings Inc.	Stoughton, USA	Fabreeka Group Holdings Inc.	100.00%	Full
Fabreeka International Inc.	Stoughton, USA	Fabreeka International Holdings Inc.	100.00%	Full
Tech Products Corporation	Miamisburg, USA	Fabreeka International Holdings Inc.	100.00%	Full
Fabreeka GmbH Deutschland	Büttelborn, Germany	Fabreeka International Holdings Inc.	100.00%	Full
Fabreeka GB Inc.	Stoughton, USA	Fabreeka International Holdings Inc.	100.00%	Full
ACE Controls Japan L.L.C.	Farmington Hills, USA	ACE Controls Inc.	100.00%	Full
ACE Stoßdämpfer GmbH	Langenfeld, Germany	Stabilus Motion Controls GmbH	94.90%	Full
		Stable II S.à r.l.	5.10%	
HAHN-Gasfedern GmbH	Aichwald, Germany	Stabilus Motion Controls GmbH	100.00%	Full
Stabilus Actio GmbH	Langenfeld, Germany	Stabilus Motion Controls GmbH	70.00%	Full

The decrease of subsidiaries is due to the ongoing simplification of the legal structure of the Stabilus Group. In fiscal year 2017, five subsidiaries were liquidated and / or merged into other group companies and two new subsidiaries were founded. This had no material effect on the Group's consolidated financial statements.

## **PRINCIPLES OF CONSOLIDATION**

The assets and liabilities of domestic and foreign entities included in the consolidated financial statements are accounted for in accordance with the uniform accounting policies of the Stabilus Group. Receivables and liabilities or provisions between the consolidated entities are eliminated. Intragroup revenue and other intragroup income and the corresponding cost and expenses are eliminated. Inter-company gains and losses on intragroup delivery and service transactions are eliminated through profit or loss, unless they are immaterial.

## **BUSINESS COMBINATION**

Business combinations are accounted for using the acquisition method as of the acquisition date, which is the date on which control is obtained by the Group. Goodwill is measured as:

- the fair value of the consideration transferred, plus
- the recognized amount of any non-controlling interests in the acquiree, less
- the net recognized amount (generally the fair value) of the identifiable assets acquired and liabilities assumed.

The consideration transferred does not include amounts related to the settlement of transactions existing before the business combination. Such amounts are generally recognized in profit or loss. Costs related to the acquisition, other than those associated with the issue of debt or equity securities that the Group incurs in connection with the business combination are expensed as incurred.

Non-controlling interests in the net assets (excluding goodwill) of consolidated subsidiaries consist of the value of those interests at the date of the original business combination and their share of changes in equity since that date.

## **FOREIGN CURRENCY TRANSLATION**

The consolidated financial statements are presented in euro (€).

For each entity in the Group its functional currency is determined, which is the currency of the primary economic environment in which the entity operates. Items included in the financial statements of each entity are measured using the functional currency. Transactions in foreign currency are initially translated into the functional currency using the exchange rate at the date of the transaction. Monetary assets and liabilities denominated in foreign currency are translated into the functional currency using the exchange rate at the balance sheet date. These foreign currency exchange gains or losses are recognized in profit and loss.

Non-monetary items in a foreign currency that are measured at historical cost are translated using the exchange rates as of the date of the initial transaction. Non-monetary items in foreign currency measured at fair value are translated using the exchange rate at the date when the fair value is determined. Any goodwill arising on the acquisition of a foreign operation and any fair value adjustments to the carrying amounts of assets and liabilities arising on the acquisition are treated as assets and liabilities of the foreign operation and translated at the historic rate.

Assets and liabilities of foreign subsidiaries with a functional currency other than euro (€) are translated using the exchange rates as at the balance sheet date, while their income and expenses are translated using the average exchange rates during the period.

Foreign currency exchange gains and losses on operating activities are included in other operating income and expense. Foreign currency gains and losses on financial receivables and debts are included in interest income and expense.

Translation adjustments arising from exchange rate differences are recognized directly in shareholder's equity and are presented as a separate component of equity. On disposal of a foreign entity, the translation adjustment relating to that particular foreign operation is recognized in profit or loss.

Exchange differences from foreign currency loans that are part of a net investment in a foreign operation are recognized directly in equity.

The exchange rates of the significant currencies of non-euro countries used in the preparation of the consolidated financial statements were as follows:

### Exchange rates

T\_018

COUNTRY	ISO CODE	Closing rate Sept 30,		Average rate for the year ended Sept 30,	
		2017	2016	2017	2016
Australia	AUD	1.5075	1.4627	1.4512	1.5098
Brazil	BRL	3.7635	3.6208	3.5306	4.0300
China	CNY	7.8534	7.4854	7.5209	7.2606
South Korea	KRW	1,351.8300	1,234.2600	1,266.6493	1,293.7400
Mexico	MXP	21.4614	21.8853	21.1129	19.9038
Romania	RON	4.5993	4.4523	4.5461	4.4853
USA	USD	1.1806	1.1223	1.1041	1.1110

## CHANGES IN ACCOUNTING POLICIES/NEW STANDARDS ISSUED

The accounting policies applied in the consolidated financial statements comply with the IFRSs required to be applied in the EU as of September 30, 2017. In financial year 2017, the following new and revised standards and interpretations had to be applied for the first time in the Group's financial statements:

### New standards, interpretations and amendments in the financial year

T\_019

STANDARD / INTERPRETATION		Effective date stipulated by IASB	Effective date stipulated by EU	Impact on Stabilus financial statements
Amendments to IFRS 10, IFRS 12 and IAS 28	Investment Entities – Applying the Consolidation Exception (issued on December 18, 2014)	January 1, 2016	January 1, 2016	No impact
Amendments to IAS 27	Equity Method in Separate Financial Statements (issued on August 12, 2014)	January 1, 2016	January 1, 2016	No impact
Amendments to IAS 1	Disclosure Initiative (issued on December 18, 2014)	January 1, 2016	January 1, 2016	Immaterial
Amendments to IAS 16 and IAS 38	Clarification of Acceptable Methods of Depreciation and Amortization (issued on May 12, 2014)	January 1, 2016	January 1, 2016	No impact
Amendments to IFRS 11	Accounting for Acquisitions of Interests in Joint Operations (issued on May 6, 2014)	January 1, 2016	January 1, 2016	No impact
Amendments to IAS 16 and IAS 41	Bearer Plants (issued on June 30, 2014)	January 1, 2016	January 1, 2016	No impact
Annual Improvements	Annual Improvements to IFRSs 2012 – 2014 Cycle (issued on September 25, 2014)	January 1, 2016	January 1, 2016	Immaterial

The effective date presented above is the date of mandatory application in annual periods beginning on or after that date.

### Standards and interpretations issued and endorsed by the EU (not yet adopted)

T\_020

STANDARD / INTERPRETATION		Effective date stipulated by IASB	Effective date stipulated by EU	Impact on Stabilus financial statements
IFRS 9	Financial Instruments (issued on July 24, 2014)	January 1, 2018	January 1, 2018	Evaluating
IFRS 15	Revenue from Contracts with Customers (issued on May 28, 2014) including amendments to IFRS 15: Effective date of IFRS 15 (issued on September 11, 2015)	January 1, 2018	January 1, 2018	Evaluating
IFRS 16	Leases (issued on January 13, 2016)	January 1, 2019	January 1, 2019	Evaluating
Amendments to IAS 12	Recognition of Deferred Tax Assets for Unrealised Losses (issued on January 19, 2016)	January 1, 2017	January 1, 2017	Evaluating
Amendments to IAS 7	Disclosure Initiative (issued on January 29, 2016)	January 1, 2017	January 1, 2017	Evaluating
Amendments to IFRS 4	Applying IFRS 9 Financial Instruments with IFRS 4 Insurance Contracts (issued on September 12, 2016)	January 1, 2018	January 1, 2018	No impact
Clarifications to IFRS 15	Revenue from Contracts with Customers (issued on April 12, 2016)	January 1, 2018	January 1, 2018	Evaluating

The effective date presented above is the date of mandatory application in annual periods beginning on or after that date.

## **IFRS 9 FINANCIAL INSTRUMENTS**

IFRS 9 Financial Instruments introduces a universal approach to the classification and measurement of financial assets and financial liabilities. In accordance with IFRS 9, all financial assets and liabilities are measured at amortized cost or fair value. The classification of financial assets to one of the two measurement categories is based on how an entity manages its financial instruments (so-called business model) and the contractual cash flow characteristics of the financial assets. Furthermore, IFRS 9 adds a new expected loss impairment model that is based on the concept of providing for expected losses at inception of a contract, except in the case of purchased or originated credit-impaired financial assets, where expected credit losses are incorporated into the effective interest rate. In addition, IFRS 9 establishes a new hedging model that represents a substantial overhaul of hedge accounting that will enable entities to better reflect their risk management activities in their financial statements. Finally, extensive disclosures are required. The new Standard is applicable to annual reporting periods beginning on or after January 1, 2018. In general IFRS 9 must be applied retrospectively, but various transition options are allowed.

## **IFRS 15 REVENUE FROM CONTRACTS WITH CUSTOMERS**

IFRS 15 Revenue from Contracts with Customers provides a single, principles-based five-step model for the determination and recognition of revenue to be applied to all contracts with customers. The new Standard replaces the existing guidance on revenue recognition, including IAS 18 Revenue, IAS 11 Construction Contracts and the relevant interpretations (IFRIC 13, IFRIC 15, IFRIC 18 and SIC-13). The core principle of IFRS 15 is that revenue will be recognized in an amount that corresponds to the consideration that the entity expects to receive. A so-called "5-step model" is used to determine at which point in time or over which period of time revenue is to be recognized and in what amount. IFRS 15 also adds the items "Contract Assets" and "Contract Liabilities" to the balance sheet. Furthermore, the standard includes detailed guidance and extended disclosure requirements. The new Standard is applicable to annual reporting periods beginning on or after January 1, 2018. The Stabilus Group is planning to apply the modified retrospective transition method, according to which the cumulative effects of the conversion to the opening balance as of October 1, 2017 must be recorded.

## **IFRS 16 LEASES**

IFRS 16 Leases changes the regulations for the recognition, measurement, presentation and disclosure of leases. IFRS 16 supersedes the previous standard for lease accounting (IAS 17 Leases) and the relating interpretations (IFRIC 4, SIC-15 and SIC-27). The objective of the new leasing standard is to recognize all leases and their associated contractual rights and obligations in the balance sheet. Therefore, the previous distinction between finance and operating lease is eliminated from the perspective of a lessee. Apart from short-term and low-value leases, IFRS 16 introduces a methodology for all lease contracts similar to that previously applied for finance leases, i.e. alongside a right-of-use asset a corresponding lease liability is also recognized upon initial recognition. Both items are updated as appropriate. When accounting for leases, lessors are still required to perform a review to classify leases as operating or finance leases. IFRS 16 will basically make it necessary to recognize all leases in the balance sheet in future financial years. For the financial statements of the Stabilus Group, this relates in particular to those rental agreements previously classified as operating leases, which are disclosed as financial commitments in the notes. As a result, non-current assets and financial debt will both increase in future financial years. Furthermore, the classification



of expenses in the income statement will change. To date, rental payments in connection with operating lease agreements were included as expenses within operating expenses. In future financial years, these expenses will be split into depreciation and interest expenses and recognized accordingly.

#### **AMENDMENTS TO IAS 12: RECOGNITION OF DEFERRED TAX ASSETS FOR UNREALIZED LOSSES**

The Amendments to IAS 12: Recognition of Deferred Tax Assets for Unrealized Losses clarify that unrealized losses on debt instruments measured at fair value result in deductible temporary differences. It also clarifies that an assessment must be made for the aggregate of all deductible temporary differences as to whether it is probable that sufficient taxable income will be available in future, to allow the temporary differences to be used and recognized. Rules and examples supplementing IAS 12 clarify how future taxable income is to be determined for recognition of deferred tax assets.

#### **AMENDMENTS TO IAS 7: DISCLOSURE INITIATIVE**

Amendments to IAS 7: A Disclosure Initiative requires that entities provide disclosures that enable users of financial statements to evaluate changes in liabilities arising from financing activities. The amendments are intended to expand the disclosure of components of changes in liabilities arising from financing activities for the purpose of reconciliation. Therefore, the amendments are expected to have an impact on the disclosures of the statement of cash flows in the notes.

The Stabilus Group is currently assessing how the application of IFRS 9, IFRS 15, IFRS 16, the Amendments to IAS 7 as well as the Amendments to IAS12 will affect the presentation of the assets, liabilities, financial position and profit or loss. The assessment has not yet been completed, thus it has not yet been possible to make a statement on or further quantification of the impact of the new standards on the assets, liabilities, financial position and profit or loss.

The IASB published new standards and amendments, whose application is not yet compulsory in financial year 2017 or which have not yet been endorsed by the EU. The Group is not planning an early application of these standards and amendments.

### Standards and interpretations issued but not yet endorsed by the EU

T\_021

		Effective date stipulated by IASB	Effective date stipulated by EU	Impact on Stabilus financial statements
IFRS 14	Regulatory Deferral Accounts (issued on January 30, 2014)	January 1, 2016	No adoption	No impact
IFRS 17	Insurance Contracts (issued May 18, 2017)	January 1, 2021	Pending	No impact
Amendments to IFRS 2	Classification and Measurement of Share-based Payment Transactions (issued on June 20, 2016)	January 1, 2018	Pending	No impact
Amendments to IAS 40	Transfers of Investment Property (issued on December 8, 2016)	January 1, 2018	Pending	No impact
Annual Improvements	Annual Improvements to IFRSs 2014-2016 Cycle (issued on December 8, 2016)	January 1, 2018 / January 1, 2017	Pending	No impact
IFRIC Interpretation 22	Foreign Currency Transactions and Advance Consideration (issued on December 8, 2016)	January 1, 2018	Pending	No impact
IFRIC Interpretation 23	Uncertainty over Income Tax Treatments (issued on June 7, 2017)	January 1, 2019	Pending	Evaluating
Amendments to IFRS 9	Prepayment Features with Negative Compensation (issued on 12 October 2017)	January 1, 2019	Pending	Evaluating
Amendments to IAS 28	Long-term Interests in Associates and Joint Ventures (issued on 12 October 2017)	January 1, 2019	Pending	No impact

The effective date presented above is the date of mandatory application in annual periods beginning on or after that date.

### IFRIC 23 UNCERTAINTY OVER INCOME TAX TREATMENTS

IFRIC 23 Uncertainty over Income Tax Treatments clarifies the accounting for uncertainties in income taxes with regard to current and deferred tax assets and liabilities. Such uncertainties in income taxes arise if the application of the tax law on a specific transaction is uncertain and is therefore dependent on how its interpretation by the relevant tax authority, which is not known to the entity at the time the consolidated financial statements are prepared. An entity takes these uncertainties into account in the tax profit (tax losses) only if it is probable that the relevant tax amounts will be paid or reimbursed.

### AMENDMENTS TO IFRS 9 PREPAYMENT FEATURES WITH NEGATIVE COMPENSATION

The International Accounting Standards Board (IASB) has published amendments to International Financial Reporting Standards (IFRS) 9, Financial Instruments that allow companies to measure particular prepayable financial assets with negative compensation at amortized cost or at fair value through other comprehensive income (FVOCI) – instead of measuring them at fair value through profit or loss (FVTPL).

The Stabilus Group is currently assessing how the application of IFRIC 23 as well as the Amendments to IFRS 9 will affect the presentation of the assets, liabilities, financial position and profit or loss. The assessment has not yet been completed, thus it has not yet been possible to make a statement on or

further quantification of the impact of the new standards on the assets, liabilities, financial position and profit or loss. The Stabilus Group is planning to conclude the detailed analyses during the course of financial year ending on September 30, 2018.

### **3 Accounting policies**

#### **REVENUE**

Revenue is recognized to the extent that it is probable that the economic benefits will flow to the Group and the revenue can be measured reliably. Revenue is measured at the fair value of the consideration received, excluding discounts, rebates, and other sales taxes or duty. Revenue from the sale of goods is recognized when significant risks and rewards of ownership have been transferred to the customer, a price is agreed or can be determined and when the payment is probable. Revenue from a contract to provide services is recognized according to the stage of completion, if the amount of the revenue can be measured reliably and it is probable that the economic benefits will flow to the Group.

#### **COST OF SALES**

Cost of sales comprises costs for the production of goods and for merchandise sold. In addition to directly attributable material and production costs, indirect production-related overheads like production and purchase management, warranty expenses, depreciation on production plants and amortization of intangible assets are included. Cost of sales also includes write-downs on inventories to the lower net realizable value.

#### **RESEARCH EXPENSES AND NON-CAPITALIZED DEVELOPMENT EXPENSES**

Research expenses and non-capitalized development expenses are recognized in profit or loss as incurred.

#### **SELLING EXPENSES**

Selling expenses include costs for sales personnel and other sales-related costs such as marketing and travelling. Shipping and handling costs are expensed within selling expenses as incurred. Fees charged to customers are shown as sales. Advertising costs (expenses for advertising, sales promotion and other sales-related activities) are expensed within selling expenses as incurred.

#### **BORROWING COSTS**

Borrowing costs are expensed as incurred, unless they are directly attributable to the acquisition, construction or production of a qualifying asset and therefore form part of the cost of that asset.

#### **INTEREST INCOME AND EXPENSE**

The interest income and expense include the interest expenses from liabilities and the interest income from the investment of cash. The interest components from defined benefit pension plans and similar obligations are reported within personnel expenses.

## **OTHER FINANCIAL INCOME AND EXPENSE**

The other financial result includes all remaining income and expenses from financial transactions that are not included in the interest income and expense.

## **INCOME TAXES**

Income tax expense comprises current and deferred tax.

Current tax comprises the expected tax payable or receivable for the year and any adjustment related to previous years and is measured using tax rates enacted or substantively enacted at the reporting date. Current tax assets and liabilities are offset only if certain criteria are met.

Deferred tax is recognized on temporary differences between the carrying value of assets and liabilities under IFRS and their tax base, except for temporary differences arising from goodwill or from the initial recognition, other than in a business combination, of assets and liabilities in a transaction that affects neither taxable nor accounting profit.

Deferred tax assets are recognized for deductible temporary differences, tax loss carry-forwards and tax credits to the extent that it is probable that future taxable profits will be available against which they can be utilized. Deferred tax assets are reviewed at each reporting date to determine whether it is probable that the related tax benefit will be realized. The carrying value is adjusted accordingly.

Deferred tax is measured at the tax rates that are expected to be applied to temporary differences when they reverse, based on tax rates enacted or substantively enacted at the reporting date. The measurement of deferred tax reflects the tax consequences that would follow from the manner in which Stabilus expects to recover or settle the carrying amount of its assets and liabilities. Deferred tax assets and liabilities are offset only if certain criteria are met.

## **GOODWILL**

Goodwill is measured at cost less any accumulated impairment losses and is not amortized. It is tested for impairment at least annually and if an indication for impairment exists.

The Group tests goodwill for impairment by comparing its recoverable amount with its carrying amount. For this purpose at the acquisition date goodwill is allocated to cash-generating units (CGU) that are expected to benefit from the business combination. Goodwill is tested for impairment at the lowest level within the Group at which goodwill is being managed.

An impairment loss on goodwill is recognized if the recoverable amount of the cash-generating unit is below its carrying amount. Impairment losses are recognized in profit or loss. Impairment losses on goodwill are not reversed.

## **OTHER INTANGIBLE ASSETS**

Purchased intangible assets are measured at acquisition cost and internally generated intangible assets at production cost less any accumulated amortization and impairment losses. Internally generated intangible assets are only recognized when the criteria in accordance with IAS 38 are met.

Intangible assets with finite useful lives are amortized on a straight-line basis over their useful economic life and tested for impairment if there is an indication that the intangible asset may be impaired. The estimated useful life and the amortization method are reviewed at the end of each reporting period. The effect of changes in the estimate is being accounted for on a prospective basis. Intangible assets with indefinite useful lives are not amortized and are tested for impairment at least annually and if an indication for impairment exists.

The following useful lives are used in the calculation of amortization: Software (3 to 5 years), patented technology (16 years), customer relationships (20-24 years), unpatented technology (6 to 10 years) and trade names (7 years).

## **RESEARCH AND DEVELOPMENT EXPENSES**

Development costs are capitalized when the criteria in accordance with IAS 38 are met, otherwise expensed as incurred.

To meet the recognition criteria of IAS 38, Stabilus has to demonstrate the following: (1) the technical feasibility of completing the intangible asset so that it will be available for use or sale; (2) the intention to complete the intangible asset and use or sell it; (3) the ability to use or sell the intangible asset; (4) how the intangible asset will generate probable future economic benefits; (5) the availability of adequate technical, financial and other resources to complete the development and to use or sell the intangible asset; and (6) the ability to measure reliably the expenditure attributable to the intangible asset during its development.

Capitalized development costs comprise all costs directly attributable to the development process and are amortized systematically from the start of production over the expected product cycle of three to fifteen years depending on the lifetime of the product.

## **PROPERTY, PLANT AND EQUIPMENT**

Property, plant and equipment is measured at cost less accumulated depreciation and impairment losses.

Cost for property, plant and equipment include the purchase price, costs directly attributable to bringing the asset to the location and condition necessary to be capable of operating in the manner intended. This also applies for self-constructed plant and equipment taking into account the cost of production.

Subsequent costs are capitalized only if they increase the future economic benefits embodied in the specific asset to which they relate.

Depreciation on property, plant and equipment is recognized on a straight-line basis over the estimated useful lives of the assets. The residual values, depreciation methods and useful lives are reviewed annually and adjusted, if necessary.

Depreciation is primarily based on the following useful lives: Buildings (40 years), machinery and equipment (5 to 10 years) and other equipment (5 to 8 years).

Stabilus recognizes government grants when there is reasonable assurance that the conditions attached to the grants are complied with and the grants will be received. Government grants related to the purchase or the production of fixed assets are generally offset against the acquisition or production costs of the respective assets so that the grant is recognized in profit or loss over the life of the asset through reduced depreciation expense.

## **LEASING**

Leases are all arrangements that transfer the right to use a specified asset for a stated period of time in return for a payment.

Leases that transfer substantially all risks and rewards associated with the ownership to Stabilus are classified as finance leases. The leased asset and a corresponding liability is initially measured at fair value or the lower present value of the minimum lease payments. Assets are depreciated on a straight-line basis over the estimated useful life of the asset or the shorter term of the lease. Lease payments resulting from finance leases are divided into repayments of the principal and interest payments.

Other leases are classified as operating leases. The corresponding lease payments are recognized as an expense in profit or loss on a straight-line basis over the lease term.

## **IMPAIRMENT OF NON-FINANCIAL ASSETS**

Stabilus assesses at each reporting date whether there is an indication that an asset may be impaired. If such indication exists Stabilus estimates the recoverable amount of the asset. Goodwill and intangible assets under construction are tested annually for impairment.

The recoverable amount is determined for individual assets, unless an asset does not generate cash inflows that are largely independent of those from other assets or groups of assets (cash-generating units).

The recoverable amount is the higher of its fair value less costs of disposal and its value in use. Stabilus determines the recoverable amount as fair value less costs of disposal and compares this with the carrying amounts (including goodwill). The fair value less costs of disposal is measured by discounting future cash flows using a risk-adjusted interest rate. The future cash flows are estimated on the basis of the operative planning (five-year window). Periods not included in the business plans are taken into account by applying a residual value which considers a growth rate of 1.0%. If the fair value less costs



of disposal cannot be determined or is lower than the carrying amount, the fair value less costs of disposal is calculated. If the carrying amount exceeds the recoverable amount an impairment loss has to be recognized.

The calculation of the value in use and the fair value less costs of disposal is most sensitive to the following assumptions: (1) Gross margins are based on average values achieved in the last two years adopted over the budget period for anticipated efficiency improvements. (2) Discount rates reflect the current market assessments of the risks of the cash-generating unit. The rate was estimated based on the average percentage of a weighted average cost of capital for the industry. (3) Estimates regarding the raw materials price developments are obtained by published indices from countries in which the resources are mainly bought. Forecast figures (mainly in Europe and the US) and past price developments have been used as an indicator for future developments. (4) Management notices that the Group's position continues to strengthen, as customers shift their purchases to larger and more stable companies. Therefore there is no need for any doubt regarding the assumption of market share. (5) Revenue growth rates are estimated based on published industry research.

At each reporting date an assessment is made to determine whether there is any indication that impairment losses recognized in earlier periods no longer exist. In this case, Stabilus recognizes a reversal of the impairment loss. Impairment losses on goodwill are not reversed.

## INVENTORIES

Inventories are measured at the lower of cost and net realizable value using the average cost method. Production costs include all direct costs of material and labor and an appropriate portion of fixed and variable overhead expenses. Net realizable value is the estimated selling price less all estimated costs of completion and costs necessary to make the sale. Borrowing costs for the production period are not included. Provisions are set up on the basis of the analysis of stock moving and / or obsolete stock.

## FINANCIAL INSTRUMENTS

A financial instrument is any contract that gives rise to a financial asset of one entity and a financial liability or an equity instrument of another entity. Financial instruments recorded as financial assets or financial liabilities are generally reported separately. Financial instruments are recognized as soon as the Stabilus Group becomes a party to the contractual provisions of the financial instrument. Financial instruments comprise financial receivables or liabilities, trade accounts receivable or payable, cash and cash equivalents and other financial assets or liabilities.

Financial instruments are initially measured at fair value. For the purpose of subsequent measurement, financial instruments are allocated to one of the categories defined in IAS 39 "Financial Instruments: Recognition and Measurement". The measurement categories relevant for Stabilus are loans and receivables, financial assets at fair value through profit or loss and financial liabilities measured at amortized costs.

### Loans and receivables

Loans and receivables are non-derivative financial assets with fixed or determinable payments that are not quoted in an active market. Examples include trade accounts receivable and loans originated by the Group. After initial recognition, loans and receivables are subsequently carried at amortized cost using the effective interest rate method less impairment losses. Gains and losses are recognized in profit or loss when the loans and receivables are derecognized or impaired. Interest from using the effective interest rate method is similarly recognized in profit or loss. Loans and receivables bearing no or lower interest rates compared to market rates with a maturity of more than one year are discounted.

## FINANCIAL ASSETS

In addition to financial instruments assigned to a measurement category, financial assets also include cash and cash equivalents. Cash and cash equivalents consist primarily of cash on hand, checks and deposits at banks. The Group considers all highly liquid investments purchased with an original maturity of three months or less to be cash equivalents. Cash and cash equivalents correspond with the classification in the consolidated statement of cash flows. Interest received on these financial assets is generally recognized in profit or loss applying the effective interest rate method. Dividends are recognized in profit or loss when legal entitlement to the payment arises.

## IMPAIRMENT OF FINANCIAL ASSETS

At each reporting date the carrying amounts of the financial assets, except those measured at fair value through profit or loss, are investigated to assess whether objective evidence of impairment (such as the debtor's inability to meet its current obligations or significant changes in the technological, economic, legal or the market environment of the debtor) exists. For equity instruments a significant or prolonged decline in fair value is considered to be objective evidence for impairment. Stabilus has defined criteria for the significance and duration of a decline in fair value.

### Loans and receivables

If there is objective evidence that an impairment loss on assets carried at amortized cost has been incurred, the amount of the loss is measured as the difference between the asset's carrying amount and the present value of estimated future cash flows (excluding future expected credit losses that have not been incurred) discounted at the financial asset's original effective interest rate (i.e. the effective interest rate computed at initial recognition). The carrying amount of the asset is reduced through use of an allowance account. The amount of the loss is recognized in profit or loss. If, in a subsequent period, the amount of the impairment loss decreases and the decrease can be related objectively to an event occurring after the impairment was recognized, the previously recognized impairment loss is reversed, to the extent that the carrying value of the asset does not exceed its amortized cost at the reversal date. Any subsequent reversal of an impairment loss is recognized in profit or loss. In relation to trade accounts receivable, a provision for impairment is made when there is objective evidence (such as the probability of insolvency or significant financial difficulties of the debtor) that the Group will be unable to collect all of the amounts due under the original terms of the invoice. The carrying amount of the receivable is reduced through use of an allowance account. Impaired debts are derecognized when they are assessed as uncollectible.

## **DERIVATIVE FINANCIAL INSTRUMENTS**

As of September 30, 2017 and September 30, 2016, the Stabilus does not have derivative financial instruments.

In the prior year, on June 21, 2016, Stabilus entered into four forward exchange transactions to hedge the foreign exchange risk related to the US dollar payment of the purchase price for the acquired SKF Group entities that had to be paid on June 30, 2016. Such derivative financial instruments were settled on June 30, 2016. The effective portion of changes in fair value of cash flow hedges in the year ended June 30, 2016 amounted to €6,798 thousand and the amount reclassified as basis adjustment amounted to €(6,798) thousand. Stabilus designated the forward exchange transactions as a hedging instrument to the US dollar purchase price, i.e. as cash flow hedge.

When a derivative is designated as a cash flow hedging instrument, the effective portion of changes in the fair value is recognized in other comprehensive income and the ineffective portion is recognized in profit and loss. The amount recognized in other comprehensive income is reclassified when the hedged transaction occurs. Stabilus considers the hedge related to a business combination as a hedge of a non-financial item and recognizes the gain or loss from the hedging instrument recognized in other comprehensive income as an adjustment to goodwill.

## **FINANCIAL LIABILITIES AND EQUITY INSTRUMENTS**

Debt and equity instruments are classified as either financial liabilities or as equity in accordance with the substance of the contractual arrangement.

### **EQUITY INSTRUMENTS**

An equity instrument is any contract that evidences a residual interest in the assets of an entity after deducting all of its liabilities. Equity instruments are recorded at the proceeds received, net of transaction costs.

### **FINANCIAL LIABILITIES**

Financial liabilities primarily include a term loan, trade accounts payable and other financial liabilities.

#### **Financial liabilities measured at amortized cost**

Financial liabilities measured at amortized cost include a term loan.

After initial recognition the financial liabilities are subsequently measured at amortized cost applying the effective interest method. Gains and losses are recognized in profit or loss through the amortization process or when the liabilities are derecognized.

#### **Financial liabilities at fair value through profit or loss**

As of September 30, 2017 and 2016, the Group does not measure any financial liabilities at fair value through profit or loss.

## PENSIONS AND SIMILAR OBLIGATIONS

The contributions to our pension plans are recognized as an expense when the entity consumes the economic benefits arising from the services provided by the employees in exchange for employee benefits. For defined benefit pension plans the projected unit credit method is used to determine the present value of a defined benefit obligation.

For the valuation of defined benefit plans, differences between actuarial assumptions used and actual developments as well as changes in actuarial assumptions result in actuarial gains and losses, which have a direct impact on the consolidated statement of financial position and on other comprehensive income.

## OTHER PROVISIONS

Provisions are recognized when the Group has a present obligation (legal or constructive) as a result of a past event, it is probable that the Group will be required to settle the obligation and a reliable estimate can be made of the amount of the obligation. All cost elements that are relevant flow into the measurement of other provisions – in particular those for warranties and potential losses on pending transactions. Non-current provisions with a residual term of more than one year are recognized at the balance sheet date with their discounted settlement amount. The amount recognized as a provision is the best estimate of the consideration required to settle the present obligation at the balance sheet date, taking into account the risks and uncertainties surrounding the obligation. Where a provision is measured using the cash flows estimated to settle the obligation, its carrying amount is the present value of those cash flows. When some or all of the economic benefits required to settle a provision are expected to be recovered from a third party, the receivable is recognized as an asset if it is virtually certain that reimbursement will be received and the amount of the receivable can be measured reliably.

A restructuring provision is recognized when the Group has developed a detailed formal plan for the restructuring and has raised a valid expectation in those affected that it will carry out the restructuring by starting to implement the plan or announcing its main features to those affected by it. The measurement of a restructuring provision includes only the direct expenditures arising from the restructuring, which are those amounts that are both necessarily entailed by the restructuring and not associated with the ongoing activities of the entity.

Termination benefits are granted if an employee is terminated before the normal retirement age or if an employee leaves the company voluntarily in return for the payment of a termination benefit. The Group records termination benefits if it is demonstrably committed, without realistic possibility of withdrawal, to a formal detailed plan to terminate the employment of current employees or if it is demonstrably committed to pay termination benefits if employees leave the company voluntarily.

Provisions for warranties are recognized at the date of sale of the relevant products, at the management's best estimate of the expenditure required to settle the Group's obligation.

## 4 Revenue

The Group's revenue developed as follows:

### Revenue by region

T\_022

IN € THOUSANDS	Year ended Sept 30,	
	2017	2016
Europe	456,306	364,195
NAFTA	350,737	288,988
Asia / Pacific and RoW	102,973	84,318
<b>Revenue</b>	<b>910,016</b>	<b>737,501</b>

### Revenue by markets

T\_023

IN € THOUSANDS	Year ended Sept 30,	
	2017	2016
Automotive Gas Spring	340,475	320,030
Automotive Powerise	243,210	195,314
Automotive business	583,685	515,344
Industrial / Capital Goods	204,408	171,015
Vibration & Velocity Control	93,920	22,540
Commercial Furniture	28,003	28,602
Industrial business	326,331	222,157
<b>Revenue</b>	<b>910,016</b>	<b>737,501</b>

Group revenue results from sales of goods. Stabilus operates in automotive and industrial markets. The Automotive Gas Spring and Automotive Powerise units service our automotive customers, whereas Industrial / Capital Goods, Vibration & Velocity Control as well as Commercial Furniture (formerly: Swivel Chair) units supply our industrial customers.

## 5 Cost of sales, research and development, selling and administrative expenses

### Expenses by function

T\_024

Year ended 30, 2017					
IN € THOUSANDS	Cost of sales	Research & development expenses	Selling expenses	Administrative expenses	Total
Capitalized development cost	–	11,405	–	–	<b>11,405</b>
Personnel expenses	(156,151)	(19,054)	(30,877)	(34,350)	<b>(240,432)</b>
Material expenses	(429,810)	(6,004)	(11,356)	(5,266)	<b>(452,436)</b>
Depreciation and amortization	(30,692)	(15,770)	(12,006)	(2,634)	<b>(61,102)</b>
Other	(20,511)	(8,771)	(26,141)	6,907	<b>(48,516)</b>
<b>Total</b>	<b>(637,164)</b>	<b>(38,194)</b>	<b>(80,380)</b>	<b>(35,343)</b>	<b>(791,081)</b>

Year ended Sept 30, 2016					
IN € THOUSANDS	Cost of sales	Research & development expenses	Selling expenses	Administrative expenses	Total
Capitalized development cost	–	12,592	–	–	<b>12,592</b>
Personnel expenses	(132,752)	(16,313)	(19,575)	(30,777)	<b>(199,417)</b>
Material expenses	(358,128)	(5,000)	(10,383)	(3,106)	<b>(376,617)</b>
Depreciation and amortization (incl. impairment losses)	(30,351)	(11,120)	(5,874)	(1,940)	<b>(49,285)</b>
Other	(26,469)	(6,749)	(19,630)	1,942	<b>(50,906)</b>
<b>Total</b>	<b>(547,700)</b>	<b>(26,590)</b>	<b>(55,462)</b>	<b>(33,881)</b>	<b>(663,633)</b>

The expense items in the statement of comprehensive income include following personnel expenses.

### Personnel expenses

T\_025

IN € THOUSANDS	Year ended Sept 30,	
	2017	2016
Wages and salaries	(172,819)	(139,127)
Compulsory social security contributions	(42,694)	(34,566)
Pension cost	(15,061)	(14,931)
Other social benefits	(9,858)	(10,793)
<b>Personnel expenses</b>	<b>(240,432)</b>	<b>(199,417)</b>



The following table shows the Group's average number of employees.

### Number of employees

T\_026

	Year ended Sept 30,	
	2017	2016
Wage earners	4,523	3,925
Salaried staff	1,341	1,042
Trainees and apprentices	100	95
<b>Average number of employees</b>	<b>5,964</b>	<b>5,062</b>

## 6 Other income

### Other income

T\_027

	Year ended Sept 30,	
	2017	2016
IN € THOUSANDS		
Foreign currency translation gains	8,817	9,795
Gains on sale / disposal of assets	276	–
Income from the release of other accruals	287	42
Miscellaneous other income	3,385	2,237
<b>Other income</b>	<b>12,765</b>	<b>12,074</b>

## 7 Other expenses

### Other expenses

T\_028

	Year ended Sept 30,	
	2017	2016
IN € THOUSANDS		
Foreign currency translation losses	(12,202)	(8,422)
Losses on sale / disposal of tangible assets	(227)	(162)
Miscellaneous other expenses	(882)	(716)
<b>Other expenses</b>	<b>(13,311)</b>	<b>(9,300)</b>

## 8 Finance income

### Finance income

T\_029

IN € THOUSANDS	Year ended Sept 30,	
	2017	2016
Interest income on loans and financial receivables not measured at fair value through profit and loss	185	47
Net foreign exchange gain	–	2,169
Gains from changes in carrying amount of financial liabilities	22,093	–
Other interest income	45	340
<b>Finance income</b>	<b>22,323</b>	<b>2,556</b>

Finance income is substantially due to the adjustment of the carrying value of the euro term loan facility reflecting the decrease in the margin based on the improved net leverage ratio of the Group with an amount of €17,485 thousand and the extension of the term by one year with an amount of €4,608 thousand.

## 9 Finance costs

### Finance costs

T\_030

IN € THOUSANDS	Year ended Sept 30,	
	2017	2016
Interest expense on financial liabilities not measured at fair value through profit and loss	(12,853)	(12,756)
Net foreign exchange loss	(16,471)	–
Interest expenses finance lease	(69)	(105)
Other interest expenses	(406)	(400)
<b>Finance costs</b>	<b>(29,799)</b>	<b>(13,261)</b>

The interest expense on finance liabilities not measured at fair value through profit and loss include ongoing interest expenses of €9,612 thousand (PY: € 8,906 thousand) related to the euro term loan facility. Thereof an amount of €2,358 thousand (PY: €2,576 thousand) is due to the amortization of debt issuance cost and the amortization of the adjustment of the carrying value by using the effective interest rate method. Furthermore the prepayments of the euro term loan facility lead to a derecognition of unamortized debt issuance cost and unamortized adjustment of the carrying value with a total amount of €3,091 thousand (PY: €3,848 thousand).

The net foreign exchange loss is primarily due to the weaker USD (closing rate per €1: \$1.12 as at September 30, 2016 versus \$1.18 as at September 30, 2017) relevant for the translation of intragroup loans and the portion of the euro term loan facility (€157.5 million) held by a US entity until September 29, 2017.

## 10 Income tax expense

Income taxes comprise current taxes on income (paid or owed) in the individual countries and deferred taxes. The tax rates which are applicable on the reporting date are used for the calculation of current taxes. Tax rates for the expected period of reversal, which are enacted or substantively enacted at the reporting date, are used for the calculation of deferred taxes. Deferred taxes are recognized as deferred tax expenses or income in the statement of comprehensive income, either through profit or loss or other comprehensive income, depending on the underlying transaction.

### Income tax expense

T\_031

IN € THOUSANDS	Year ended Sept 30,	
	2017	2016
Current income taxes	(37,893)	(29,961)
Deferred taxes	6,223	12,010
<b>Income tax expense</b>	<b>(31,670)</b>	<b>(17,951)</b>

The respective local rates have been used to calculate the deferred taxes. The current income taxes comprise prior year taxes amounting to €(1.793) thousand (PY: €16 thousand).

The actual income tax expense of €(31,670) thousand deviates in the amount of €1,603 thousand from the expected tax expense of €(33,273) thousand that results from applying the expected income tax rate of 30% to the Group's profit or loss before income taxes. The individual items that reconcile the expected income tax expense to the actual income tax expense are disclosed in the table below.

### Tax expense reconciliation (expected to actual)

T\_032

IN € THOUSANDS	Year ended Sept 30,	
	2017	2016
<b>Profit / (loss) before income tax</b>	<b>110,913</b>	<b>65,938</b>
<b>Expected income tax expense</b>	<b>(33,273)</b>	<b>(19,781)</b>
Foreign tax rate differential	5,677	2,767
Tax-free income	3,292	50
Non-deductible expenses	(5,958)	(2,251)
Prior year taxes	(1,793)	(16)
Change of the valuation allowance on deferred tax assets	518	564
Tax rate changes	96	65
Other	(230)	652
<b>Actual income tax expense</b>	<b>(31,670)</b>	<b>(17,951)</b>
<b>Effective tax rate</b>	<b>28.6%</b>	<b>27.2%</b>

The tax effect reported as a foreign tax rate differential reflects the difference between the expected tax rate of 30% and the actual tax rates that are applicable to the individual subsidiaries. The tax effect of non-deductible expenses consists primarily of expenses that are non-deductible in the determination of the taxable profits in Germany. The tax effect of non-capitalized deferred taxes on domestic losses is calculated with the local tax rates on the basis of the negative earnings before taxes (EBTs) of the respective companies.

The deferred tax assets (DTA) and deferred tax liabilities (DTL) in respect of each type of the temporary difference and each type of unused tax losses are as follows:

### Deferred tax assets and liabilities

T\_033

IN € THOUSANDS	Sep 30, 2017			Sep 30, 2016		
	DTA	DTL	Total	DTA	DTL	Total
Intangible assets	165	(71,393)	(71,228)	224	(78,492)	(78,268)
Property, plant & equipment	3,000	(7,522)	(4,522)	2,766	(8,136)	(5,370)
Inventories	3,255	(83)	3,172	2,515	(101)	2,414
Receivables	493	(1,124)	(631)	1,476	(1,868)	(392)
Other assets	584	(3,401)	(2,817)	838	(4,701)	(3,863)
Provisions and liabilities	14,511	(1,044)	13,467	15,470	(384)	15,086
Tax and interest losses	14,606	–	14,606	17,502	–	17,502
<b>Subtotal</b>	<b>36,614</b>	<b>(84,567)</b>	<b>(47,953)</b>	<b>40,791</b>	<b>(93,682)</b>	<b>(52,891)</b>
Netting	(24,531)	24,531	–	(33,048)	33,048	–
<b>Total</b>	<b>12,083</b>	<b>(60,036)</b>	<b>(47,953)</b>	<b>7,743</b>	<b>(60,634)</b>	<b>(52,891)</b>

Deferred tax assets and deferred tax liabilities have been offset if they relate to income taxes levied by the same tax authorities and if there is a right to offset current tax assets against current tax liabilities.

As of September 30, 2017, the Group has unused tax loss carry-forwards (including German interest loss carry-forwards) of €59,949 thousand (PY: €74,144 thousand).

The following table provides a detailed overview of the tax loss and interest carry-forwards and the expiration dates.

**Tax loss and interest carry-forwards**

T\_034

Year ended Sept 30, 2017						
IN € THOUSANDS	Tax loss and interest carry-forward	Tax rate	Deferred tax asset (gross)	Valuation allowance	Deferred tax asset (net)	Expiration date
Germany	47,693	27 – 30%	12,872	(698)	12,175	Indefinite
Spain	5,192	28.0%	1,454	(1,454)	–	Indefinite
USA	5,666	36.2%	2,049	–	2,049	Within 20 years
Great Britain	273	22.0%	60	(60)	–	Indefinite
Brazil	1,125	34.0%	383	–	383	Indefinite
<b>Total</b>	<b>59,949</b>		<b>16,818</b>	<b>(2,212)</b>	<b>14,606</b>	

Year ended Sept 30, 2016						
IN € THOUSANDS	Tax loss and interest carry-forward	Tax rate	Deferred tax asset (gross)	Valuation allowance	Deferred tax asset (net)	Expiration date
Germany	65,756	27.0 – 30.0%	17,724	(647)	17,076	Indefinite
Spain	5,671	28.0%	1,588	(1,588)	–	Indefinite
USA	1,143	37.0%	423	(423)	–	Within 20 years
Great Britain	321	22.0%	71	(71)	–	Indefinite
Brazil	1,253	34.0%	426	–	426	Indefinite
<b>Total</b>	<b>74,144</b>		<b>20,231</b>	<b>(2,729)</b>	<b>17,502</b>	

The interest carry-forward comes from our German entities and amounts to €45,031 thousand with a gross deferred tax asset of €12,091 thousand of which a deferred tax assets of €12,091 thousand was shown in the balance sheet. The unused tax loss carry-forward comprises €14,918 thousand relating to corporate tax and trade tax. The amount recognized as a deferred tax asset is calculated under consideration of the actual corporate planning and its utilization within the planning period.

Tax loss carry-forwards in Luxembourg are not considered, as it is not likely that these carry-forwards will be utilized.

## 11 Earnings per share

The weighted average number of shares used for the calculation of earnings per share in the fiscal years ended September 30, 2017 and 2016 is set out in the following table:

Weighted average number of shares					T_035	
DATE	Number of days	Transaction	Change	Total shares	Total shares (time-weighted)	
<b>September 30, 2015</b>				<b>20,723,256</b>	<b>20,723,256</b>	
October 1, 2015	279			20,723,256	15,797,236	
July 6, 2016	87	Capital increase	3,976,744	24,700,000	5,871,311	
<b>September 30, 2016</b>				<b>24,700,000</b>	<b>21,668,547</b>	
October 1, 2016	365			24,700,000	24,700,000	
<b>September 30, 2017</b>				<b>24,700,000</b>	<b>24,700,000</b>	

The earnings per share for the fiscal years ended September 30, 2017 and 2016, were as follows:

Earnings per share		T_036	
		Year ended Sept 30,	
		2017	2016
Profit / (loss) attributable to shareholders of the parent (in € thousands)		79,255	47,971
Weighted average number of shares		24,700,000	21,668,547
<b>Earnings per share (in €)</b>		<b>3.21</b>	<b>2.21</b>

Basic and diluted earnings per share are calculated by dividing the profit attributable to the shareholders of the Company by the weighted average number of shares outstanding.



## 12 Property, plant and equipment

Property, plant and equipment are presented in the following table.

### Property, plant and equipment

T\_037

IN € THOUSANDS	Land, equivalent rights to real property	Buildings and land improve- ments	Technical equipment and machinery	Other tangible equipment	Construc- tion in pro- gress	Total
<b>Gross value</b>						
<b>Balance as of Sept 30, 2015</b>	<b>10,926</b>	<b>37,966</b>	<b>133,006</b>	<b>36,918</b>	<b>26,334</b>	<b>245,150</b>
Additions from business combination	2,662	9,887	7,726	1,872	970	23,117
Foreign currency difference	(2)	(242)	(4,364)	(295)	(353)	(5,256)
Additions	–	2,016	27,495	4,358	6,360	40,229
Disposals	–	(71)	(957)	(634)	(335)	(1,997)
Reclassifications	–	1,516	7,656	1,892	(11,064)	–
<b>Balance as of Sept 30, 2016</b>	<b>13,586</b>	<b>51,072</b>	<b>170,562</b>	<b>44,111</b>	<b>21,912</b>	<b>301,243</b>
Foreign currency difference	(181)	(1,307)	(4,976)	(1,759)	(315)	(8,538)
Additions	2,817	744	11,886	6,317	11,972	33,736
Disposals	(1,179)	(1,987)	(1,719)	(2,226)	(833)	(7,944)
Reclassifications	–	526	13,986	2,032	(16,544)	–
<b>Balance as of Sept 30, 2017</b>	<b>15,043</b>	<b>49,048</b>	<b>189,739</b>	<b>48,475</b>	<b>16,192</b>	<b>318,497</b>
<b>Accumulated depreciation</b>						
<b>Balance as of Sept 30, 2015</b>	–	<b>(9,684)</b>	<b>(76,851)</b>	<b>(23,844)</b>	<b>(819)</b>	<b>(111,198)</b>
Foreign currency difference	–	(30)	1,874	222	–	2,066
Depreciation expense	–	(3,064)	(16,284)	(6,540)	–	(25,888)
<i>Thereof impairment loss</i>	–	–	–	–	–	–
Disposal	–	53	760	533	–	1,346
Reclassifications	–	(3)	1	2	–	–
<b>Balance as of Sept 30, 2016</b>	–	<b>(12,728)</b>	<b>(90,500)</b>	<b>(29,627)</b>	<b>(819)</b>	<b>(133,674)</b>
Foreign currency difference	–	579	3,031	1,326	–	4,936
Depreciation expense	–	(2,620)	(16,769)	(7,005)	–	(26,394)
<i>Thereof impairment loss</i>	–	–	(389)	(5)	–	(394)
Disposal	–	1,648	1,630	2,197	819	6,294
Reclassifications	–	–	(3)	3	–	–
<b>Balance as of Sept 30, 2017</b>	–	<b>(13,121)</b>	<b>(102,611)</b>	<b>(33,106)</b>	–	<b>(148,838)</b>
<b>Carrying amount</b>						
<b>Balance as of Sept 30, 2016</b>	<b>13,586</b>	<b>38,344</b>	<b>80,062</b>	<b>14,484</b>	<b>21,093</b>	<b>167,569</b>
<b>Balance as of Sept 30, 2017</b>	<b>15,043</b>	<b>35,927</b>	<b>87,128</b>	<b>15,369</b>	<b>16,192</b>	<b>169,659</b>

Property, plant and equipment include assets resulting from two finance lease contracts with a carrying amount of €3,767 thousand (PY: €4,133 thousand).

In fiscal year 2017, Stabilus Group has not received government grants (PY: €201 thousand). Prior years government grants are linked to the installation of our third Powerise production line in Romania. For the entitlement to this grant Stabilus Romania S.R.L. has to meet certain thresholds (headcount and quantity of products) over a five-year period. If such thresholds were not met, the grant would have to be paid back.

Contractual commitments for the acquisition of property, plant and equipment amount to €5,775 thousand (PY: €5,397 thousand).

The Group recognized impairment losses on Property, plant and equipment amounting to €394 thousand (PY: €0 thousand) in the actual year.

The total depreciation expense for tangible assets is included in the consolidated statement of comprehensive income in the following line items:

### Depreciation expense for property, plant and equipment

T\_038

IN € THOUSANDS	Year ended Sept 30,	
	2017	2016
Cost of sales	(23,599)	(23,485)
Research and development expenses	(955)	(741)
Selling expenses	(468)	(374)
Administrative expenses	(1,372)	(1,288)
<b>Depreciation expense</b>	<b>(26,394)</b>	<b>(25,888)</b>

Prepayments by the Stabilus Group for property, plant and equipment and intangible assets of €507 thousand (PY: €746 thousand) are included in other non-current assets. Larger prepayments are typically secured by a bank guarantee or an in-depth check of the relevant supplier.

## 13 Goodwill

The first-time consolidation of Stable II S.à r. l, Luxembourg as of April 8, 2010, resulted in goodwill of €51.1 million and the first-time consolidation of Orion Rent Imobiliare S.R.L, Bucharest, Romania resulted in goodwill of €0.4 million. The first-time consolidation of ACE, Hahn Gasfedern and Fabreeka/Tech Products as of June 30, 2016, resulted in goodwill of €146.9 million. The acquisition of a small niche business in New Zealand resulted in a goodwill of €0.2 million. These acquisitions resulted in total goodwill of €198.6 million (PY: €51.5 million). On the relevant acquisition date goodwill is allocated to the operating segments (CGUs) based on their relative fair values. As such €112.4 million have been allocated to Europe, €73.3 million to NAFTA and €12.9 million to Asia/Pacific and Rest of World (RoW).

The foreign currency difference on goodwill is €(3.3) million (PY: €(1.1) million).

The fair value less cost of disposal for each cash-generating unit as the smallest identifiable group of assets that generates cash inflows that are largely independent of the cash inflows from other assets or other groups of assets is measured by discounting the future cash flows generated from the continuing use of the unit and was based on the following key assumptions: the underlying cash flow forecasts are based on the five-year medium term plan ("MTP") approved by the Management Board and Supervisory Board. The cash flow planning takes into account price agreements based on experience and anticipated efficiency enhancements (e.g. relocation from high cost to low cost countries, higher automation, etc.) as well as average total sales growth of approximately 1.8% (PY: 5.0%) for Europe, 2.6% (PY: 5.2%) for NAFTA and 16.1% (PY: 18.2%) for Asia / Pacific and RoW on compound average based on the strategic outlook leading to an average higher growth rate for the free cash flow. The higher free cash flow growth rate is also impacted by the product mix effects and the assumed stable gross margins and improved fixed costs absorption. While the overall economic outlook is very volatile, the Group believes that its market-orientated approach and leading edge products and services allow for some revenue growth. Cash flows after the five-year period were extrapolated by applying a 1% (PY: 1%) growth rate. This growth rate was based on the expected consumer price inflation for the countries included in the respective cash generating units, adjusted for expected technological progress and efficiency gains in the overall economy. The discount rate applied to cash flow projections is 8.9% (PY: 8.8%) for Europe, 8.6% (PY: 8.5%) for NAFTA and 8.8% (PY: 8.4%) for Asia / Pacific and RoW. The pre-tax discount rates are 11.8% (PY: 11.5%) for Europe, 12.9% (PY: 12.5%) for NAFTA and 11.6% (PY: 11.0%) for Asia / Pacific and RoW.

The following table shows the input data to selected key figures required for the respective recoverable amounts to equal the carrying amount. In management's view this change is not reasonably possible.

### Goodwill sensitivity analysis

T\_039

	Sept. 30, 2017		
IN PERCENT	Input data required for carrying amount to equal recoverable amount		
	Europe	NAFTA	RoW
Discount rate	6.5	17.6	13.2
Budgeted gross margin reduction to plan	4.1	11.5	8.9
Sustainable growth rate after 5-year period	(7.1)	(68.9)	(45.1)

## 14 Other intangible assets

Other intangible assets are presented in the following table.

Intangible assets								T_040
IN € THOUSANDS	Develop- ment cost	Develop- ment cost under construc- tion	Software	Patents	Customer relation- ship	Tech- nology	Trade name	Total
<b>Gross value</b>								
<b>Balance as of Sept 30, 2015</b>	<b>67,828</b>	<b>25,940</b>	<b>7,050</b>	<b>1,238</b>	<b>83,683</b>	<b>58,132</b>	<b>13,246</b>	<b>257,117</b>
Additions from business combination	–	–	1,099	–	123,568	11,625	3,616	139,908
Foreign currency difference	(62)	35	2	(24)	(802)	(103)	(23)	(977)
Additions	3,463	9,428	865	27	–	–	–	13,783
Disposals	(57)	–	(236)	–	–	–	–	(293)
Reclassifications	12,727	(12,911)	105	79	–	–	–	–
<b>Balance as of Sept 30, 2016</b>	<b>83,899</b>	<b>22,492</b>	<b>8,885</b>	<b>1,320</b>	<b>206,449</b>	<b>69,654</b>	<b>16,839</b>	<b>409,538</b>
Additions from business combination	–	–	–	–	–	–	–	–
Foreign currency difference	(1,155)	764	(867)	(13)	(2,327)	(406)	(65)	(4,069)
Additions	1,773	7,583	2,401	3	–	–	–	11,760
Disposals	(14,287)	–	(666)	–	–	–	–	(14,953)
Reclassifications	14,332	(15,659)	1,327	–	–	–	–	–
<b>Balance as of Sept 30, 2017</b>	<b>84,562</b>	<b>15,180</b>	<b>11,080</b>	<b>1,310</b>	<b>204,122</b>	<b>69,248</b>	<b>16,774</b>	<b>402,276</b>
<b>Accumulated amortization</b>								
<b>Balance as of Sept 30, 2015</b>	<b>(31,693)</b>	–	<b>(4,517)</b>	<b>(1,078)</b>	<b>(19,177)</b>	<b>(30,130)</b>	<b>(4,047)</b>	<b>(90,642)</b>
Foreign currency difference	43	–	(4)	24	14	1	–	78
Amortization expense	(10,213)	–	(1,321)	(48)	(5,335)	(5,616)	(865)	(23,398)
<i>Thereof impairment loss</i>	<i>(741)</i>	–	–	–	–	–	–	<i>(741)</i>
Disposals	5	–	234	–	–	–	–	239
Reclassifications	–	–	(23)	23	–	–	–	–
<b>Balance as of Sept 30, 2016</b>	<b>(41,858)</b>	–	<b>(5,631)</b>	<b>(1,079)</b>	<b>(24,498)</b>	<b>(35,745)</b>	<b>(4,912)</b>	<b>(113,723)</b>
Foreign currency difference	497	–	108	12	228	32	14	891
Amortization expense	(14,628)	–	(2,127)	(78)	(10,859)	(5,765)	(1,251)	(34,708)
<i>Thereof impairment loss</i>	<i>(2,390)</i>	–	<i>(76)</i>	–	–	–	–	<i>(2,466)</i>
Disposals	13,537	–	638	–	–	–	–	14,175
Reclassifications	–	–	–	–	–	–	–	–
<b>Balance as of Sept 30, 2017</b>	<b>(42,452)</b>	–	<b>(7,012)</b>	<b>(1,145)</b>	<b>(35,129)</b>	<b>(41,478)</b>	<b>(6,149)</b>	<b>(133,365)</b>
<b>Carrying amount</b>								
<b>Balance as of Sept 30, 2016</b>	<b>42,041</b>	<b>22,492</b>	<b>3,254</b>	<b>241</b>	<b>181,951</b>	<b>33,909</b>	<b>11,927</b>	<b>295,815</b>
<b>Balance as of Sept 30, 2017</b>	<b>42,110</b>	<b>15,180</b>	<b>4,068</b>	<b>165</b>	<b>168,993</b>	<b>27,770</b>	<b>10,625</b>	<b>268,911</b>

Additions to intangible assets in the fiscal year 2017 amounted to €11,760 thousand (PY: €13,783 thousand) and mainly comprised capitalized development cost amounted to €9,356 thousand (PY: €12,891 thousand) (less related customer contributions).

Amortization of capitalized internal development projects amounted to €14,628 thousand (PY: €9,472 thousand). The borrowing costs capitalized during the period amounted to €208 thousand (PY: €299 thousand). A capitalization rate was used to determine the amount of borrowing costs. The capitalization rate used from October 2016 to April 2017 was 2.0%, and from May to September 2017 was 1.5% (PY: 2.0%).

The total amortization expense and impairment loss for intangible assets is included in the consolidated statements of comprehensive income in the following line items:

#### Amortization expense for intangible assets

T\_041

IN € THOUSANDS	Year ended Sept 30,	
	2017	2016
Cost of sales	(7,093)	(6,867)
Research and development expenses	(14,628)	(10,379)
Selling expenses	(11,537)	(5,500)
Administrative expenses	(1,450)	(652)
<b>Amortization expense (incl. impairment loss)</b>	<b>(34,708)</b>	<b>(23,398)</b>

Amortization expenses on development costs include impairment losses of €2,390 thousand (PY: €741 thousand) due to the withdrawal of customers from the respective projects. The impairment loss is included in the research and development expenses.

Contractual commitments for the acquisition of intangible assets amount to €1,686 thousand (PY: €3,214 thousand).

## 15 Other financial assets

#### Other financial assets

T\_042

IN € THOUSANDS	Sept 30, 2017			Sept 30, 2016		
	Current	Non-current	Total	Current	Non-current	Total
Other miscellaneous	5,155	–	5,155	3,160	–	3,160
<b>Other financial assets</b>	<b>5,155</b>	<b>–</b>	<b>5,155</b>	<b>3,160</b>	<b>–</b>	<b>3,160</b>

## OTHER MISCELLANEOUS

Other miscellaneous financial assets in the fiscal year 2017 mainly comprise assets related to the sale of trade accounts receivable (€27.6 million (PY: €23.3 million)) amounting to €3,657 thousand (PY: €3,160 thousand) and a receivable amounting to €1,498 thousand from the sale of the land and building of Stabilus Spain, where the activity was shut down in 2011.

## 16 Other assets

### Other assets

T\_043

IN € THOUSANDS	Sept 30, 2017			Sept 30, 2016		
	Current	Non-current	Total	Current	Non-current	Total
VAT	3,570	–	3,570	5,698	–	5,698
Prepayments	3,062	507	3,569	2,925	746	3,671
Deferred charges	4,274	–	4,274	3,178	–	3,178
Other miscellaneous	1,812	2,444	4,256	2,122	2,521	4,643
<b>Other assets</b>	<b>12,718</b>	<b>2,951</b>	<b>15,669</b>	<b>13,923</b>	<b>3,267</b>	<b>17,190</b>

Non-current prepayments comprise prepayments on property, plant and equipment.

## 17 Inventories

### Inventories

T\_044

IN € THOUSANDS	Sept 30, 2017	Sept 30, 2016
Raw materials and supplies	39,876	38,076
Finished products	22,095	17,103
Work in progress	14,203	12,616
Merchandise	9,088	6,886
<b>Inventories</b>	<b>85,262</b>	<b>74,681</b>

Inventories that are expected to be turned over within twelve months amounted to €85,262 thousand (PY: €74,681 thousand). Write-downs on inventories to net realizable value amounted to €8,482 thousand (PY: €6,545 thousand). In the reporting period raw materials, consumables and changes in finished goods and work in progress recognized as cost of sales amounted to €429,810 thousand (PY: €358,128 thousand).

The Stabilus Group's prepayments for inventories amounting to €1,607 thousand (PY: €1,457 thousand) are included in prepayments in other current assets.

## 18 Trade accounts receivable

Trade accounts receivable include the following items:

### Trade accounts receivable

T\_045

IN € THOUSANDS	Sept 30, 2017	Sept 30, 2016
Trade accounts receivable	107,693	99,827
Allowance for doubtful accounts	(2,546)	(2,227)
<b>Trade accounts receivable</b>	<b>105,147</b>	<b>97,600</b>

Trade accounts receivable increased in the fiscal year ended September 30, 2017 mainly due to the higher sales partly compensated by the additional sale of receivables to factors.

The Group provides credit in the normal course of business and performs ongoing credit evaluations on certain customers' financial condition, but generally does not require collateral to support such receivables. The Group established an allowance for doubtful accounts based upon factors such as the credit risk of specific customers, historical trends and other information.

The allowances for doubtful accounts developed as follows:

### Allowance for doubtful accounts

T\_046

IN € THOUSANDS	Sept 30, 2017	Sept 30, 2016
<b>Allowance for doubtful accounts as of beginning of fiscal year</b>	<b>(2,227)</b>	<b>(2,196)</b>
Additions from business combination	–	(170)
Foreign currency differences	75	(35)
Increase in the allowance	(460)	(211)
Decrease in the allowance	66	385
<b>Allowance for doubtful accounts as of fiscal year-end</b>	<b>(2,546)</b>	<b>(2,227)</b>

## 19 Current tax assets

Current tax assets are measured at the amount expected to be recovered from the taxation authorities when the amount already paid in respect of current and prior periods exceeds the amount due for those periods.



## **20 Cash and cash equivalents**

Cash and cash equivalents include cash on hand and in banks, i.e. liquid funds and demand deposits. As of September 30, 2017, it amounted to €68,123 thousand (PY: €75,037 thousand). Cash in banks earned marginal interest at floating rates based on daily bank deposit rates.

## **21 Equity**

The development of the equity is presented in the statement of changes in equity.

### **Issued capital**

Issued capital as of September 30, 2017 amounted to €247 thousand (September 30, 2016 €247 thousand) and was fully paid in. It is divided into 24,700,000 shares each with a nominal value of €0.01. The authorized capital of the Company is set at €315 thousand represented by a maximum of 31.5 million shares, each with nominal value of €0.01.

### **Capital reserves**

Capital reserves as of September 30, 2017 amounted to €225,848 thousand (September 30, 2016 €225,848 thousand).

### **Retained earnings**

Retained earnings as of September 30, 2017 amounted to €139,440 thousand (September 30, 2016 €72,535 thousand) and included the Group's net result in the fiscal year 2017 amounting to €79,255 thousand.

### **Dividends**

In the second quarter of fiscal 2017, a dividend amounting to €12.35 million (PY: -) was paid to our shareholders and a dividend amounting to €54 thousand (PY: €78 thousand) was paid to a non-controlling shareholder of a Stabilus subsidiary.

The Management Board and the Supervisory Board have resolved to propose a dividend distribution of €0.80 per share to the Annual General Meeting to be held in Luxembourg on February 14, 2018. The total dividend will thus amount to €19.76 million (PY: €12.35 million) and the distribution ratio will be 24.9% of the consolidated profit attributable to the Stabilus shareholders. As this dividend is subject to shareholder approval at the Annual General Meeting, no liability has been recognized in the consolidated financial statements as of September 30, 2017.

### Other reserves

Other reserves comprise all foreign currency differences arising from the translation of the financial statements of foreign operations and unrealized actuarial gains and losses. The following table shows the changes in other reserves recognized in equity through other comprehensive income as well as the income tax recognized in equity through other comprehensive income.

### Other comprehensive income / (expense)

T\_047

IN € THOUSANDS	Unrealized gains/ (losses) from foreign currency translation	Unrealized actuarial gains and losses	Cash flow hedges <sup>1)</sup>	Total
<b>Balance as of Sept 30, 2015</b>	<b>(12,767)</b>	<b>(8,717)</b>	–	<b>(21,484)</b>
Before tax	(8,858)	(7,841)	–	(16,699)
Tax (expense) / benefit	–	2,351	–	2,351
Other comprehensive income / (expense), net of taxes	(8,858)	(5,490)	–	(14,348)
Non-controlling interest	–	–	–	–
<b>Balance as of Sept 30, 2016</b>	<b>(21,625)</b>	<b>(14,207)</b>	–	<b>(35,832)</b>
Before tax	3,328	4,591	–	7,919
Tax (expense) / benefit	–	(1,285)	–	(1,285)
Other comprehensive income / (expense), net of taxes	3,328	3,306	–	6,634
Non-controlling interest	–	–	–	–
<b>Balance as of September 30, 2017</b>	<b>(18,297)</b>	<b>(10,901)</b>	–	<b>(29,198)</b>

<sup>1)</sup> See also consolidated statement of comprehensive income above

Cash flow hedges in the table above, with a net amount of zero, relate to four forward exchange transactions the Company entered into on June 21, 2016 to hedge the foreign exchange risk related to the US dollar purchase price for the acquired SKF Group entities that had to be paid on June 30, 2016. Stabilus designated the forward exchange transactions as a hedging instrument to the US dollar purchase price, i.e. as a cash flow hedge. The effective portion of changes in fair value of cash flow hedges in the year ended September 30, 2016 amounted to €6,798 thousand and the amount reclassified as basis adjustment amounted to €(6,798) thousand. See also Consolidated Statement of Comprehensive Income and further details regarding accounting treatment of cash flow hedges in Note 2 above. During the year ended September 30, 2017, there was no derivative qualifying for cash flow hedge accounting.

## 22 Financial liabilities

The financial liabilities comprise following items:

<b>Financial liabilities</b>				T_048		
IN € THOUSANDS	Sept 30, 2017			Sept 30, 2016		
	Current	Non-current	Total	Current	Non-current	Total
Senior facilities	10,000	311,951	321,951	5,000	396,095	401,095
<b>Financial liabilities</b>	<b>10,000</b>	<b>311,951</b>	<b>321,951</b>	<b>5,000</b>	<b>396,095</b>	<b>401,095</b>

On June 7, 2016, Stabilus entered into a €640.0 million senior facilities agreement with, among others, Commerzbank Aktiengesellschaft, Crédit Agricole Corporate and Investment Bank, Landesbank Hessen-Thüringen Girozentrale and UniCredit Bank AG as mandated lead arrangers and UniCredit Luxembourg S. A. as facility and security agent. The agreement comprises a term loan facility of €455.0 million, an equity bridge facility of €115.0 million and a revolving credit facility of €70.0 million. The term loan facility and the revolving credit facility originally mature on June 29, 2021. The duration of the senior facilities (other than the equity bridge facility) has been extended by one additional year at the Company's request to June 29, 2022 and can be extended by a second year, at the Company's request until June 29, 2018.

The term loan facility has to be repaid in full on the termination date June 29, 2022.

The expected semi-annual prepayments of €5.0 million on March 31 and September 30, 2018 are presented as current financial liabilities.

Stabilus repaid €50.0 million on August 31, 2016, €10.0 million on December 31, 2016, €2.5 million on March 31 and €50.0 million on September 30, 2017 and reduced the outstanding nominal amount to €342.5 million as at September 30, 2017.

The Group's liability under the senior facility agreement (the remaining €342.5 million term loan) is measured at amortized cost under consideration of transaction costs and the adjustment of the carrying value using the effective interest rate method. The adjustment of the carrying value of the euro term loan facility reflects the change in estimated future cash flows discounted with the original effective interest rate due to a decreased margin based on the improved net leverage ratio of the Group and the extension of the maturity by one year.

As at September 30, 2017, the Group had no liability under the committed €70.0 million revolving credit facility. The Group utilized €3.5 million out of the €70.0 million revolving credit facility to secure existing guarantees.

## 23 Other financial liabilities

### Other financial liabilities

T\_049

IN € THOUSANDS	Sept 30, 2017			Sept 30, 2016		
	Current	Non-current	Total	Current	Non-current	Total
Liabilities to employees	6,796	–	6,796	6,648	–	6,648
Social security contribution	2,514	–	2,514	2,440	–	2,440
Finance lease obligation	303	1,830	2,133	311	2,314	2,625
<b>Other financial liabilities</b>	<b>9,613</b>	<b>1,830</b>	<b>11,443</b>	<b>9,399</b>	<b>2,314</b>	<b>11,713</b>

The finance lease obligation relates to leasing contracts for land and buildings for the production facility in Romania.

## 24 Provisions

### Provisions

T\_050

IN € THOUSANDS	Sept 30, 2017			Sept 30, 2016		
	Current	Non-current	Total	Current	Non-current	Total
Anniversary benefits	29	105	134	–	61	61
Early retirement contracts	811	1,851	2,662	36	2,599	2,635
Employee-related costs	12,099	–	12,099	11,050	–	11,050
Environmental protection	48	1,421	1,469	415	990	1,405
Other risks	2,868	–	2,868	1,521	–	1,521
Legal and litigation costs	111	–	111	115	–	115
Warranties	12,984	–	12,984	12,227	–	12,227
Other miscellaneous	4,111	394	4,505	5,534	131	5,665
<b>Provisions</b>	<b>33,061</b>	<b>3,771</b>	<b>36,832</b>	<b>30,898</b>	<b>3,781</b>	<b>34,679</b>

The non-current provisions developed as follows:

**Changes of non-current provisions**

T\_051

IN € THOUSANDS	Anniversary benefits	Early retirement	EPA provision	Other miscellaneous	<b>Total</b>
<b>Balance as of Sept 30, 2015</b>	–	<b>860</b>	–	<b>172</b>	<b>1,032</b>
Additions from business combination	61	–	–	–	61
Reclassifications	–	–	–	–	–
Foreign currency differences	–	–	–	–	–
Costs paid	–	–	–	(41)	(41)
Release to income	–	–	–	–	–
Additions	–	1,739	990	–	2,729
<b>Balance as of Sept 30, 2016</b>	<b>61</b>	<b>2,599</b>	<b>990</b>	<b>131</b>	<b>3,781</b>
Reclassifications	–	–	–	–	–
Foreign currency differences	(3)	(1)	(24)	29	1
Costs paid	–	–	–	–	–
Release to income	–	(747)	–	–	(747)
Additions	47	–	455	234	736
<b>Balance as of Sept 30, 2017</b>	<b>105</b>	<b>1,851</b>	<b>1,421</b>	<b>394</b>	<b>3,771</b>

The discount rate used for the calculation of non-current provisions as of September 30, 2017 was 0.0% (PY: 0.0%).

The development of current provisions is set out in the table below:

**Changes of current provisions**

T\_052

IN € THOUSANDS	Employee-related costs	Environmental protection measures	Other risks	Legal and litigation costs	Anniversary benefits	Early retirement	Warranties	Other miscellaneous	Total
<b>Balance as of Sept 30, 2015</b>	<b>9,082</b>	<b>376</b>	<b>1,035</b>	<b>90</b>	<b>13</b>	<b>659</b>	<b>7,938</b>	<b>935</b>	<b>20,128</b>
Additions from business combination	1,178	–	176	–	–	–	86	1,210	2,650
Foreign currency differences	(808)	–	(2)	25	–	–	(1,132)	(131)	(2,048)
Reclassifications	–	–	–	–	–	–	–	–	–
Costs paid	(9,038)	–	(669)	–	(13)	(623)	(5,253)	(2,076)	(17,672)
Release to income	(133)	–	(19)	–	–	–	–	(10)	(162)
Additions	10,769	39	1,000	–	–	–	10,588	6,106	28,502
<b>Balance as of Sept 30, 2016</b>	<b>11,050</b>	<b>415</b>	<b>1,521</b>	<b>115</b>	<b>–</b>	<b>36</b>	<b>12,227</b>	<b>5,534</b>	<b>30,898</b>
Foreign currency differences	972	4	230	(4)	(2)	–	375	(388)	1,187
Reclassifications	99	–	–	–	–	–	–	(158)	(59)
Costs paid	(8,970)	(371)	(1,085)	–	–	(42)	(4,594)	(3,649)	(18,711)
Release to income	(837)	–	(229)	–	–	–	(332)	(169)	(1,567)
Additions	9,785	–	2,431	–	31	817	5,308	2,941	21,313
<b>Balance as of Sept 30, 2017</b>	<b>12,099</b>	<b>48</b>	<b>2,868</b>	<b>111</b>	<b>29</b>	<b>811</b>	<b>12,984</b>	<b>4,111</b>	<b>33,061</b>

The provision for employee-related expenses comprises employee bonuses and termination benefits.

The provision for environmental protections measures relate to the 1985 vacated former Stabilus Inc. US site in Colmar, PE, USA at the North Penn Area 5. In the meantime this North Penn Area 5 has been identified by the United States Environmental Protection Agency (EPA) as an area requiring environmental remediation. In 2011, the EPA contacted seven companies in the North Penn Area 5 as potential responsible parties for cost sharing, Stabilus being one of them. The Group is currently unable to develop a reasonable estimate of its share of the ultimate obligation as cost apportionment method of the EPA and Stabilus insurance reimbursement are unclear at this point in time. As such, no liability for an EPA reimbursement has been reflected in the balance sheet as of September 30, 2017. For the corresponding ongoing long-term bioremediation a current provision of €48 thousand (PY: €415 thousand) and a non-current provision of €1,421 thousand (PY: €990 thousand) has been recorded as of September 30, 2017.

The provision for other risks from purchase and sales commitments represents expected sales discounts, expected losses from pending deliveries of goods and other sales-related liabilities.

The provision for legal and litigation costs represents costs of legal advice and notary charges as well as the costs of litigation.

The provision for warranties represents the accrued liability for pending risks from warranties offered by the Group for their products. The Group issues various types of contractual warranties under which it generally guarantees the performance of products delivered and services rendered. The Group accrues for costs associated with product warranties at the date products are sold. This also comprises accruals that are calculated for individual cases. Insurance reimbursements related to individual cases are presented in other financial assets if the recognition criteria are met.

## **25 Pension plans and similar obligations**

Liabilities for the Group's pension benefit plans and other post-employment plans comprise the following:

### **Pension plans and similar obligations**

IN € THOUSANDS	Sept 30, 2017	Sept 30, 2016
Principal pension plan	52,081	57,422
Deferred compensation	1,155	1,316
<b>Pension plans and similar obligations</b>	<b>53,236</b>	<b>58,738</b>

T\_053

### **DEFINED BENEFIT PLANS AND DEFERRED COMPENSATION**

#### **Defined benefit plan**

The Stabilus Group granted post-employment pension benefits to employees in Germany. The level of post-employment benefits is generally based on eligible compensation levels and/or ranking within the Group hierarchy and years of service.

In order to mitigate future liquidity risk, the Group's pension policies for one major plan granted to employees, who joined the Group prior to January 1, 2006, were amended as of December 21, 2010 and the title earned in the former defined benefit plan was frozen. Going forward no additional defined benefit titles can be earned except for certain older employees. At the same time, the Group introduced a defined contribution plan in which direct payments to an external insurer are made.

Liabilities for principal pension plans amounting to €52,081 thousand (PY: €57,422 thousand) result from unfunded accumulated benefit obligations.

The weighted average duration of the defined benefit obligations in the fiscal year 2017 is 16.5 years (PY: 16.4 years).

#### **Deferred compensation**

The deferred compensation is a form of retirement pay which is financed by the employees, where, based on an agreement between the Group and the employees, part of their income is retained by the Group and paid to the respective employees after retirement.



The total deferred compensation as of September 30, 2017 amounts to €1,155 thousand (PY: €1,316 thousand).

The unfunded status is as follows:

<b>Unfunded status</b>		T_054	
IN € THOUSANDS		Year ended Sept 30,	
		2017	2016
Present value of defined benefit obligations		53,236	58,738
Less: Fair value of plan assets		–	–
<b>Unfunded status</b>		<b>53,236</b>	<b>58,738</b>

The present value of the defined benefit obligation developed as follows:

<b>Present value of defined benefit obligations</b>		T_055	
IN € THOUSANDS		Year ended Sept 30,	
		2017	2016
<b>Present value of defined benefit obligations as of beginning of fiscal year</b>		<b>58,738</b>	<b>47,989</b>
Value of defined benefit obligations from business combinations		–	2,877
Service cost		233	68
Interest cost		785	1,133
Financial assumptions		(4,825)	8,932
Experience assumptions		234	(1,055)
Actuarial (gains) / losses		(4,591)	7,877
Pension benefits paid		(1,929)	(1,206)
<b>Present value of defined benefit obligations as of fiscal year-end</b>		<b>53,236</b>	<b>58,738</b>

The pension cost in the consolidated statement of comprehensive income includes the following expenses for defined benefit plans:

<b>Pension cost for defined benefit plans</b>		T_056	
IN € THOUSANDS		Year ended Sept 30,	
		2017	2016
Service cost		233	68
Interest cost		785	1,133
<b>Pension cost for defined benefit plans</b>		<b>1,018</b>	<b>1,201</b>

The present value of the defined benefit obligation and the experience adjustments arising on the plan liabilities are as follows:

**Present value of the defined benefit obligation and the experience adjustments on the plan liabilities**

IN € THOUSANDS	Defined benefit obligation	Experience adjustments
Sept 30, 2013	39,123	(213)
Sept 30, 2014	48,353	914
Sept 30, 2015	47,989	(205)
Sept 30, 2016	58,738	(1,055)
Sept 30, 2017	53,236	234

T\_057

Generally, the measurement date for Group's pension obligations is September 30. The measurement date for Group's net periodic pension cost generally is the beginning of the period. Assumed discount rates, salary increases and long-term return on plan assets vary according to the economic conditions in the country in which the pension plan is situated.

Following assumptions (measurement factors) were used to determine the pension obligations:

**Significant factors for the calculation of pension obligations**

IN % P. A.	Year ended Sept 30,	
	2017	2016
Discount rate	1.87%	1.35%
Inflation	1.50%	0.00%
Salary increases	0.00%	0.00%
Pension increases	1.50%	1.50%
Turnover rate	4.00%	4.00%

T\_058

The discount rates for the pension plans are determined annually as of August 31 on the basis of first-rate, fixed-interest industrial bonds with maturities and values matching those of the pension payments.

**SENSITIVITY ANALYSIS**

If the discount rate were to differ by +0.5% / -0.5% from the interest rate used at the balance sheet date, the defined benefit obligation for pension benefits would be an estimated €4,076 thousand lower or €4,642 thousand higher. If the future pension increase used were to differ by +0.2% / -0.2% from management's estimates, the defined benefit obligation for pension benefits would be an estimated €1,328 thousand higher or €1,279 thousand lower. The reduction / increase of the mortality rates by 1 years results in an increase / deduction of life expectancy depending on the individual age of

each beneficiary. The effects on the defined benefit obligation (the "DBO") as of September 30, 2017 due to a 1 year reduction / increase of the life expectancy would result in an increase of €1,994 thousand or a decrease of €2,029 thousand.

When calculating the sensitivity of the DBO to significant actuarial assumptions, the same method (present value of the DBO calculated with the projected unit credit method) has been applied as when calculating the post-employment benefit obligation recognized in the Consolidated Statement of Financial Position. Increases and decreases in the discount rate or the rate of pension progression which are used in determining the DBO do not have a symmetrical effect on the DBO due to the compound interest effect created when determining the net present value of the future benefit. If more than one of the assumptions is changed simultaneously, the combined impact due to the changes would not necessarily be the same as the sum of the individual effects due to the changes. If the assumptions change at a different level, the effect on the DBO is not necessarily in a linear relation.

Expected pension benefit payments for the fiscal year 2018 will amount to €1,882 thousand (PY: €2,018 thousand).

#### **DEFINED CONTRIBUTION PLANS**

The expenses incurred under defined contribution plans are primarily related to government-run pension plans. Expenses for these plans in the reporting period amounted to €14,084 thousand (PY: €13,263 thousand).

### **26 Trade accounts payable**

Trade accounts payable amount to €79,073 thousand (PY: €80,389 thousand) as of the end of the fiscal year. The full amount is due within one year. The liabilities are measured at amortized cost. For information on liquidity and exchange rate risks for trade accounts payable, please see Note 32.

### **27 Current tax liabilities**

The current tax liabilities relate to income and trade taxes.

## 28 Other liabilities

The following table sets out the breakdown of Group's other current and non-current liabilities:

Other liabilities				T_059		
				Sept 30, 2017		
				Sept 30, 2016		
IN € THOUSANDS	Current	Non-current	Total	Current	Non-current	Total
Advanced payments received	2,807	–	2,807	1,353	879	2,232
Vacation expenses	3,396	–	3,396	3,329	–	3,329
Other personnel related expenses	6,517	–	6,517	6,964	–	6,964
Outstanding costs	2,472	–	2,472	3,619	–	3,619
Miscellaneous	240	–	240	224	–	224
<b>Other liabilities</b>	<b>15,432</b>	<b>–</b>	<b>15,432</b>	<b>15,489</b>	<b>879</b>	<b>16,368</b>

## 29 Leasing

### OPERATING LEASE

The Group entered into non-cancellable operating leases for IT hardware, cars and other machinery and equipment with lease terms of 2 to 6 years. The future minimum lease payments relating to leasing agreements during the basic rental period when they cannot be terminated are as follows:

Operating lease		T_060	
		Minimum lease payments in the year ended Sept 30,	
IN € THOUSANDS		2017	2016
Within one year		6,677	5,702
After one year but not more than five years		15,886	17,988
More than five years		165	95
<b>Total</b>		<b>22,728</b>	<b>23,785</b>

The increase in total minimum lease payments for one year is primarily due to the expansion of the rented production facilities in China and Mexico and the decrease after one year but not more than five years is due to favorable amendments of leasing contracts.

Current period expense for operating leases amounts to €8,358 thousand (PY: €7,387 thousand).

## FINANCE LEASE

### Finance lease

T\_061

IN € THOUSANDS	Sept 30, 2017		Sept 30, 2016	
	Minimum lease payments (MLP)	Present value of MLP	Minimum lease payments (MLP)	Present value of MLP
Within one year	613	555	628	601
After one year but not later than five years	2,990	2,854	2,763	2,223
More than five years	62	60	942	733
<b>Total</b>	<b>3,665</b>	<b>3,469</b>	<b>4,333</b>	<b>3,557</b>

As of September 30, 2017, there are two real estate lease contracts regarding a production facility in Romania recorded as finance lease.

#### Production facility:

Orion Rent Immobiliare S.R.L, Brasov, entered into a non-cancellable real estate finance lease agreement on December 31, 2010 (prior to Stabilus Group taking over a controlling interest in this company) with a term of 144 months prior to the Stabilus Group becoming a controlling shareholder of Orion Rent Immobiliare S.R.L. The agreement contains a purchase option starting at the end of the third year of the contract, for a purchase price amounting to the capital that remains to be paid up to the expiry of the contract less early payment fee (between 2.75% and 4.75% of the remaining capital to be paid). The net carrying amount of the finance lease obligation at the balance sheet date is €846 thousand (PY: €916 thousand). The lease term started on January 1, 2011. The leasing fees are settled in euro, but payable in new Romanian lei. They include a variable component of the total funding cost with 3-month Euribor as the reference basis.

Stabilus Romania S.R.L. entered into a real estate lease agreement which was classified as a finance lease starting March 1, 2015. On July 1, 2016, Stabilus Romania S.R.L. renewed the real estate lease agreement to extend the existing production facility for the production of gas springs and dampers. The underlying interest rate amounts to 4.75% (PY: 4.75%). The net carrying amount of the finance lease obligation at the balance sheet date was €1,287 thousand (PY: €1,709 thousand). The contract has duration of 75 months and can be extended.

The payments for finance leases in the fiscal year ended September 30, 2017 amounted to €547 thousand (PY: €471 thousand). No contingent rents have been recognized as an expense during the period.

## **30** Contingent liabilities and other financial commitments

### **CONTINGENT LIABILITIES**

Contingent liabilities are uncertainties for which the outcome has not been determined. If the outcome is probable and estimable, the liability is shown in the statement of financial position.

In regards to a potential contingent obligation in the EPA Colmar, please see Note 24.

### **GUARANTEES**

On October 11, 2005, Stabilus Romania S.R.L., Brasov, ("STRO") entered into a rental agreement with ICCO SRL (ICCO) for a production facility used for production facilities with an area of 8,400 square meters for STRO in Brasov, Romania. The initial rental agreement has a contract period of seven years which has been extended to support production space, requirements for the transfer of certain production steps to Romania. STAB Dritte Holding GmbH, Koblenz, merged into Stable Beteiligungs GmbH, Koblenz, a wholly owned subsidiary of the Company, issued a bank guarantee for €600 thousand (PY: €600 thousand), in the event that STRO will be unable to pay. Stabilus GmbH, Koblenz, issued a letter of support for the event that STRO will be unable to pay.

On September 22, 2005, Stabilus S. A. de C. V. ("STMX") entered into a lease agreement with Deutsche Bank Mexico, S. A., and Kimex Industrial BEN, LLC, for a production facility with an area of 28,951 square meters of land and 5,881 square meters of construction buildings in Ramos Arizpe, State of Coahuila, Mexico. The lease agreement has a contract period of ten years and will be extended. Stabilus GmbH, Koblenz, issued a letter of support for the event that STMX will be unable to pay.

On June 7, 2016, the Group entered into a senior facilities agreement. Certain material subsidiaries of the Group are guarantors, as defined in the senior facilities agreement, give a credit guarantee in favor of the financing parties. The guarantees are subject to limitations, including being limited to the extent that otherwise the guarantee would amount to unlawful financial assistance and other jurisdiction-specific tests (e.g. net assets).

Given a normal course of the economic development as well as a normal course of business, management believes these guaranties should not result in a material adverse effect for the Group.

### **OTHER FINANCIAL COMMITMENTS**

The nominal value of the other financial commitments as of September 30, 2017 amounted to €30,575 thousand (PY: €32,396 thousand).

Nominal values of other financial commitments are as follows:

### Financial commitments

T\_062

		Sept 30, 2017			
IN € THOUSANDS		Less than 1 year	1 to 5 years	More than 5 years	Total
Capital commitments for fixed and other intangible assets		7,847	–	–	7,847
Obligations under rental and leasing agreements		6,677	15,886	165	22,728
<b>Total</b>		<b>14,524</b>	<b>15,886</b>	<b>165</b>	<b>30,575</b>

		Sept 30, 2016			
IN € THOUSANDS		Less than 1 year	1 to 5 years	More than 5 years	Total
Capital commitments for fixed and other intangible assets		8,611	–	–	8,611
Obligations under rental and leasing agreements		5,702	17,988	95	23,785
<b>Total</b>		<b>14,313</b>	<b>17,988</b>	<b>95</b>	<b>32,396</b>

## 31 Financial instruments

The following table shows the carrying amounts and fair values of the Group's financial instruments. The fair value is the price that would be received to sell an asset or paid to transfer a liability in an orderly transaction between market participants at the measurement date.

### Financial instruments

T\_063

		Sept 30, 2017		Sept 30, 2016	
IN € THOUSANDS		Carrying amount	Fair value	Carrying amount	Fair value
Trade accounts receivables	LaR	105,147	105,147	97,600	97,600
Cash	LaR	68,123	68,123	75,037	75,037
Other financial assets	LaR	5,155	5,155	3,160	3,160
<b>Total financial assets</b>		<b>178,425</b>	<b>178,425</b>	<b>175,797</b>	<b>175,797</b>
Financial liabilities	FLAC	321,951	321,435	401,095	376,191
Trade accounts payable	FLAC	79,073	79,073	80,389	80,389
Finance lease liabilities	–	2,133	3,469	2,625	3,557
<b>Total financial liabilities</b>		<b>403,157</b>	<b>403,977</b>	<b>484,109</b>	<b>460,137</b>
<b>Aggregated according to categories in IAS 39:</b>					
Loans and receivables (LaR)		178,425	178,425	175,797	175,797
Financial liabilities measured at amortized cost (FLAC)		401,024	400,508	481,484	456,580



The following table provides an overview of the classification of financial instruments presented above in the fair value hierarchy, except for financial instruments with fair values corresponding to the carrying amounts (i.e. trade accounts receivable and payable, cash and other financial liabilities).

## Financial instruments

T\_064

IN € THOUSANDS	Sept 30, 2017				Sept 30, 2016			
	Total	Level 1 <sup>1)</sup>	Level 2 <sup>2)</sup>	Level 3 <sup>3)</sup>	Total	Level 1 <sup>1)</sup>	Level 2 <sup>2)</sup>	Level 3 <sup>3)</sup>
<b>Financial liabilities</b>								
Senior facilities	321,435	–	321,435	–	376,191	–	376,191	–
Finance lease liabilities	3,469	–	–	3,469	3,557	–	–	3,557

<sup>1)</sup> Fair value measurement based on quoted prices (unadjusted) in active markets for these or identical instruments.

<sup>2)</sup> Fair value measurement based on inputs that are observable on active markets either directly (i. e. as prices) or indirectly (i. e. derived from prices).

<sup>3)</sup> Fair value measurement based on inputs that are not observable market data.

The fair value is the price that would be received to sell an asset or paid to transfer the liability in an orderly transaction between market participants at the measurement date. The following methods and assumptions were used to estimate the fair values in the previous fiscal year:

- The fair value of the quoted senior secured notes is based on price quotations at the reporting date.
- The valuation technique used for the determination of the obligations under finance leases is the discounted cash flow method. The valuation model considers the present value of expected payments, discounted using a risk-adjusted discount rate depending on the maturity of the payment. The expected payments are determined by considering contractual redemption payments and interest payments with the currently agreed interest rate. Significant unobservable inputs are the risk-adjusted discount rates, which range from 7.5% to 10.1%, and the forecasted interest payments. Therefore, the fair value would change if the risk-adjusted discount rate or the interest rate changed.
- The fair value of embedded derivative instruments is calculated using a standard option pricing model. For the valuation, the credit spread used is calibrated such that the model reproduces the current market of the notes quoted on the Luxembourg Stock Exchange at the reporting date.

The finance lease contracts include fixed-interest rates. Therefore, the fair value of finance lease liabilities (categorized as Level 3 in the fair value hierarchy table) are not exposed to interest risk through fluctuation.

The net gains and losses on financial instruments result in the fiscal year ended September 30, 2017 from the currency translation and changes in the estimate of future cash flows of loans and receivables and financial liabilities measured at amortized cost, as well as gains from changes in fair value of derivative instruments. They are set out in Notes 8 and 9. The net foreign exchange loss amounted to €16,471 thousand (PY: gain €2,169 thousand).

Total interest income and expense from financial instruments is reported in Notes 8 and 9.

The value of the embedded derivatives was affected by the interest of the comparable market instrument on each potential exercise date and will rise if the relevant interest rate declines and vice versa.

## **32 Risk reporting**

### **INTERNAL RISK MANAGEMENT**

The Group employs within the budgeting process an integrated system for the early identification and monitoring of risks specific to the Group, in order to identify changes in the business environment and deviations from targets at an early stage and to initiate countermeasures in advance. This includes monthly short and medium-term analysis of the order intake and the sales invoicing behavior. Control impulses for the individual companies are derived from this. Customer behavior is ascertained and analyzed continuously and the information obtained from this serves as an early warning indicator for possible changes in demand patterns.

In addition, significant KPIs (order intake, sales and EBIT, staffing level, quality indicators) are reported monthly by all Group companies and are assessed by Group management.

### **FINANCIAL RISKS**

The Group's Corporate Treasury function provides services to the business, co-ordinates access to domestic and international financial markets, and monitors and manages the financial risks relating to the operations of the Group. These risks include credit risk, liquidity risk and market risk (including currency risk and fair value interest rate risk).

The Group seeks to minimize the effects of financial risks by using derivative financial instruments to hedge these exposures wherever useful. The use of financial derivatives is governed by the Group's policies approved by the Management Board, which provide principles on foreign currency risk, interest rate risk, credit risk, the use of financial derivatives and non-derivative financial instruments, and the investment of excess liquidity. The Group does not enter into or trade financial instruments, including derivative financial instruments, for speculative purposes. The Group does not have any derivative financial instruments as of September 30, 2017.

### **CREDIT RISKS**

Credit risk refers to the risk that counterparty will default on its contractual obligations resulting in financial loss to the Group. The Group has adopted a policy of dealing only with creditworthy counterparties and obtaining sufficient collateral where appropriate, as a means of mitigating the risk of financial loss from defaults. The Group's exposure and the credit ratings of its counterparties are monitored and the aggregate value of transactions concluded is spread amongst approved counterparties.

Trade accounts receivable consist of a large number of customers, spread across diverse industries and geographical areas. Credit evaluation is performed on the financial condition of accounts receivable and, where viewed appropriate, credit guarantee insurance cover is purchased. Besides this, commercial considerations impact the credit lines per customer.

The maximum exposure to credit risk of financial assets is the carrying amount as follows:

### Credit risks included in financial assets

T\_065

		Sept 30, 2017					
IN € THOUSANDS	Neither past due nor impaired	< 30 days	30 – 60 days	60 – 90 days	90 – 360 days	> 360 days	Total
<b>Financial assets</b>							
Trade accounts receivable	98,509	4,821	965	190	620	42	105,147
Other miscellaneous	5,155	–	–	–	–	–	5,155
<b>Total</b>	<b>103,664</b>	<b>4,821</b>	<b>965</b>	<b>190</b>	<b>620</b>	<b>42</b>	<b>110,302</b>

		Sept 30, 2016					
IN € THOUSANDS	Neither past due nor impaired	< 30 days	30 – 60 days	60 – 90 days	90 – 360 days	> 360 days	Total
<b>Financial assets</b>							
Trade accounts receivable	88,026	7,016	958	598	404	598	97,600
Other financial assets	3,160	–	–	–	–	–	3,160
<b>Total</b>	<b>91,186</b>	<b>7,016</b>	<b>958</b>	<b>598</b>	<b>404</b>	<b>598</b>	<b>100,760</b>

Credit risk of other financial assets of the Group, which comprise cash and cash equivalents, and miscellaneous financial assets, arises from default of the counterparty, with a maximum exposure equal to the carrying amount of these instruments.

The Group does not have any critical credit risk exposure to any single counterparty or any group of counterparties having similar characteristics. The credit risk on liquid funds is limited because the counterparties are banks with high credit ratings assigned by international credit rating agencies and are also typically lenders to the Group. Therefore, credit quality of financial assets which are neither past due nor impaired is assessed to be good.

In fiscal year 2017, the Group had three customers which accounted for at least 12% of total external revenue. The revenue with these customers was €109,304 thousand (PY: €82,069 thousand), €88,062 thousand (PY: €81,559 thousand) and €80,272 thousand (PY: €78,344 thousand), respectively. In fiscal year 2017 and 2016, such revenue was generated in all three operating segments.

### LIQUIDITY RISKS

The Management Board has established an appropriate liquidity risk management framework for the management of the Group's short, medium and long-term funding and liquidity management requirements. The Group manages liquidity risk by maintaining adequate reserves, banking facilities and reserve borrowing facilities and by monitoring forecast cash flows at regular intervals.

The following maturities summary shows how cash flows from the Group's liabilities as of September 30, 2017 will influence its liquidity situation. The summary describes the course of the undiscounted principal and interest outflows of the financing liabilities and the undiscounted cash outflows of the trade accounts payable. The undiscounted cash outflows are subject to the following conditions: If the counterparty can request payment at different dates, the liability is included on the basis of the earliest payment date. The underlying terms and conditions are described in Note 22.

### Liquidity outflows for liabilities

T\_066

IN € THOUSANDS	Senior facility	Finance lease	Trade accounts payable	<b>Total</b>
2018	13,570	613	79,073	93,256
2019	13,465	615	–	14,080
2020	13,360	621	–	13,981
2021	13,255	876	–	14,131
2022	304,869	878	–	305,747
After 2022	–	62	–	62
<b>Total</b>	<b>358,519</b>	<b>3,665</b>	<b>79,073</b>	<b>441,257</b>

The senior facilities give planning stability over the next years. At the balance sheet date, the Group has undrawn committed facilities of €70.0 million (PY: €70.0 million) to reduce liquidity risks.

### FINANCE MARKET RISKS

The Group's activities expose it primarily to the financial risks of changes in foreign currency exchange rates (see below) and interest rates (see below). As of September 30, 2017, the Group has not entered into any derivative financial instruments. The Group monitors closely its exposure to interest rate risk and foreign currency risk and regularly checks the opportunities of entering into a variety of derivative financial instruments.

#### Exchange rate risk

Due to its subsidiaries, the Group has significant assets and liabilities outside the Eurozone. These assets and liabilities are denominated in local currencies. When the net asset values are converted into euro, currency fluctuations result in period to period changes in those net asset values. The Group's equity position reflects these changes in net asset values. The Group does not hedge against these structural currency risks.

The Group also has transactional currency exposures which arise from sales or purchases in currencies other than the functional currency and loans in foreign currencies. In order to mitigate the impact of currency exchange rate fluctuations for the operating business, the Group continually assesses its exposure and attempts to balance sales revenue and costs in a currency to thus reduce the currency risk.

Besides the balance sheet the Group's revenue and costs are also impacted by currency fluctuations.

An 1% increase/decrease in value of US dollar compared to Euro would lead to an increase/decrease of EBIT of approximately €0.5 million.

### Interest rate risk

The Group is exposed to interest rate risks, which mainly relate to debt obligations, as the Group financing is based on Euribor-related credit agreements.

The interest rate risk is monitored by using the cash flow sensitivity of the Group's cash flows due to floating interest loans.

An 1% increase of floating interest rates (Euribor) would lead to an increase of financial expense of approximately €3.4 million. As the Euribor is below 0% as of September 30, 2017 a decrease has no effect on financial expenses.

## 33 Capital management

The Stabilus Group's capital management covers both equity and liabilities. A further objective is to maintain a balanced mix of debt and equity.

Due to the broad product range and the activities on global markets, the Stabilus Group generates under normal economic conditions predictable and sustainable cash flows.

The equity ratio as of September 30, 2017 is calculated as follows:

### Equity ratio

T\_067

IN € THOUSANDS	Year ended Sept 30,	
	2017	2016
Equity	336,380	262,892
Total assets	929,995	937,412
Equity ratio	36.2%	28.0%

The Stabilus Group is not subject to externally imposed capital requirements.

The ratio of net debt to adjusted EBITDA (earnings before interest, taxes, depreciation and amortization), which is also used as a covenant in the senior facilities agreement, is an important financial ratio (debt ratio) used in the Stabilus Group. The objective is to improve the debt ratio in the future. The Company does not expect a breach of this covenant.

## **34 Notes to the consolidated statement of cash flows**

The statement of cash flows is prepared in compliance with IAS 7. The statement of cash flows of the Stabilus Group shows the development of the cash flows from operating, investing and financing activities. Inflows and outflows from operating activities are presented in accordance with the indirect method and those from investing and financing activities by the direct method.

The cash funds reported in the statement of cash flows comprise all liquid funds, cash balances and cash at banks reported in the statement of financial position.

Interest payments of €8,280 thousand (PY: €6,984 thousand) are reflected in cash outflows from financing activities. Income tax payments of €32,090 thousand (PY: €13,599 thousand) are recognized in cash flows from operating activities

## **35 Segment reporting**

The Stabilus Group is organized and managed primarily on a regional level. The three reportable operating segments of the Group are Europe, NAFTA and Asia / Pacific including RoW. The product portfolio is largely similar in these three regional segments.

The Group measures the performance of its operating segments through a measure of segment profit or loss (key performance indicator) which is referred to as "adjusted EBIT". Adjusted EBIT represents EBIT, adjusted for exceptional non-recurring items (e.g. restructuring or one-time advisory costs) and depreciation / amortization of fair value adjustments resulting from purchase price allocations (PPA).

Segment information for the fiscal years ended September 30, 2017 and 2016 is as follows:

### Segment reporting

T\_068

	Europe		NAFTA		Asia / Pacific and RoW	
	Year ended Sept 30,		Year ended Sept 30,		Year ended Sept 30,	
IN € THOUSANDS	2017	2016	2017	2016	2017	2016
External revenue <sup>1)</sup>	456,306	364,195	350,737	288,988	102,972	84,318
Intersegment revenue <sup>1)</sup>	30,418	28,038	24,689	9,556	653	758
Total revenue <sup>1)</sup>	486,724	392,233	375,426	298,544	103,625	85,076
Depreciation and amortization (incl. impairment losses)	(32,426)	(24,384)	(12,721)	(7,877)	(5,155)	(4,346)
EBIT	63,015	46,026	51,806	32,066	14,368	11,230
Adjusted EBIT	67,963	52,920	55,142	33,423	14,526	11,318

	Total segments		Other / Consolidation		Stabilus Group	
	Year ended Sept 30,		Year ended Sept 30,		Year ended Sept 30,	
IN € THOUSANDS	2017	2016	2017	2016	2017	2016
External revenue <sup>1)</sup>	910,016	737,501	–	–	910,016	737,501
Intersegment revenue <sup>1)</sup>	55,760	38,352	(55,760)	(38,352)	–	–
Total revenue <sup>1)</sup>	965,776	775,853	(55,760)	(38,352)	910,016	737,501
Depreciation and amortization (incl. impairment losses)	(50,302)	(36,607)	(10,800)	(12,678)	(61,103)	(49,286)
EBIT	129,189	89,322	(10,800)	(12,678)	118,389	76,644
Adjusted EBIT	137,631	97,661	–	–	137,631	97,661

<sup>1)</sup> Revenue breakdown by location of Stabilus company (i.e. "billed-from view").

The column "Other / Consolidation" includes among others the effects from the purchase price allocation for the April 2010 business combination. The effects from the purchase price allocation for the June 2016 business combination are included in the regions.

The EBIT of operating segment Europe in the fiscal year ended September 30, 2017 includes impairment losses of €(2,860) thousand (PY: €(741) thousand). The amounts presented in the column "Other / Consolidation" above include the elimination of transactions between the segments and certain other corporate items which are related to the Stabilus Group as a whole and are not allocated to the segments, e.g. depreciation from purchase price allocations.



The following table sets out the reconciliation of the total segments' profit (adjusted EBIT) to profit before income tax.

### Reconciliation of the total segments' profit to profit / (loss) before income tax

T\_069

IN € THOUSANDS	Year ended Sept 30,	
	2017	2016
<b>Total segments' profit (adjusted EBIT)</b>	<b>137,631</b>	<b>97,661</b>
Other/ consolidation	–	–
<b>Group adjusted EBIT</b>	<b>137,631</b>	<b>97,661</b>
Adjustments to EBIT	(19,242)	(21,017)
<b>Profit from operating activities (EBIT)</b>	<b>118,389</b>	<b>76,644</b>
Finance income	22,323	2,556
Finance costs	(29,799)	(13,261)
<b>Profit / (loss) before income tax</b>	<b>110,913</b>	<b>65,938</b>

In fiscal year 2017, the definition of adjusted EBIT has been slightly modified as interest cost on pensions recognized in EBIT will not be adjusted out anymore. The presentation of prior periods has been changed accordingly, i.e. the adjusted EBIT reported in our annual report for the fiscal year 2016 was €1.1 million higher.

The information about geographical areas is set out in the following tables:

### Geographical information: Revenue by country

T\_070

IN € THOUSANDS	Year ended Sept 30,	
	2017	2016
Germany	331,964	262,546
Romania	119,829	100,508
UK	4,513	1,141
<b>Europe</b>	<b>456,306</b>	<b>364,195</b>
Mexico	185,154	169,985
USA	165,583	119,003
<b>NAFTA</b>	<b>350,737</b>	<b>288,988</b>
China	67,410	53,741
South Korea	12,855	11,751
Brazil	7,561	5,181
Australia	6,643	6,760
Japan	6,511	5,273
New Zealand	1,993	1,612
<b>Asia / Pacific and RoW</b>	<b>102,973</b>	<b>84,318</b>
<b>Revenue</b>	<b>910,016</b>	<b>737,501</b>

**Geographical information: Non-current assets by country**

T\_071

IN € THOUSANDS	Year ended Sept 30,	
	2017	2016
Germany	233,998	246,838
Romania	26,496	24,269
Spain	910	2,542
Luxembourg	647	720
UK	6,325	6,827
Switzerland	75	79
France	13	6
Goodwill	111,921	112,081
<b>Europe</b>	<b>380,385</b>	<b>393,362</b>
USA	95,356	106,238
Mexico	28,170	25,188
Goodwill	69,649	72,572
<b>NAFTA</b>	<b>193,175</b>	<b>203,998</b>
China	35,328	37,888
South Korea	8,967	10,373
Brazil	1,875	1,961
Australia	975	1,005
Japan	1,277	1,484
New Zealand	444	462
Goodwill	12,613	12,804
<b>Asia / Pacific and RoW</b>	<b>61,479</b>	<b>65,977</b>
<b>Total</b>	<b>635,039</b>	<b>663,337</b>

The non-current assets above exclude financial instruments, deferred tax assets, post-employment benefit assets and rights arising under insurance contracts.

## **36** Share-based payments

The Group established share-based payment arrangements for members of the Management Board (Matching Stock Program) and for senior management employees (Phantom Stock Program).

### **MATCHING STOCK PROGRAM**

The variable compensation for the members of the Management Board includes a matching stock program. The matching stock program (the "MSP") provides for four annual tranches granted each year during the financial year ending September 30, 2014 until September 30, 2017. Participation in the matching stock program requires Management Board members to invest in shares of the Company. The investment has generally to be held for the lock-up period.

As part of the matching stock program A (the "MSP A") for each share the Management Board invests in the Company in the specific year (subject to general cap), the Management Board members receive a certain number of fictitious options to acquire shares in the Company for each tranche of the matching stock program. The amount of stock options received depends upon a factor to be set by the Supervisory Board (Remuneration Committee) annually in a range between 1.0 and 1.7 times for a certain tranche. Thus, if a Management Board member were to buy 1,000 shares under the MSP A in the Company, he would receive 1,000 to 1,700 fictitious options for a certain tranche. The fictitious options are subject to a lock-up period of four years and may be exercised during a subsequent two-year exercise period.

As part of matching stock program B (the "MSP B") for each share the Management Board holds in the Company in the specific year (subject to a general cap), the Management Board members receive a certain number of fictitious options to acquire shares in the Company for each tranche of the matching stock program. The amount of stock options received depends upon a factor to be set by the Supervisory Board (Remuneration Committee) annually which will be in a range between 0.0 and 0.3 times for a certain tranche. Thus, if a Management Board member were to be holding 1,000 shares under the MSP B in the Company, he would receive 0 to 300 fictitious options for a certain tranche.

The fictitious options are subject to a lock-up period of four years and may be exercised during a subsequent two-year exercise period. The options may only be exercised if the stock price of the Company exceeds a set threshold for the relevant tranche, which the Supervisory Board will determine at the time of granting the options, and which needs to be between 10% and 50% growth over the base price, which is the share price on the grant date. If exercised, the fictitious options are transformed into a gross amount equaling the difference between the option price and the relevant stock price multiplied by the number of exercised options. The Company plans a cash settlement. The maximum gross amounts resulting from the exercise of the fictitious options of one tranche in general is limited in amount to 50% of the base price. Reinvestment of IPO proceeds from previous equity programs is not taken into account for MSP A.

## PHANTOM STOCK PROGRAM

The Group initiated for 2015 and 2016 a Phantom Stock Program for ten senior management employees excluding Stabilus S. A. directors. To participate in the program, the employees have to invest a certain amount in Stabilus shares. The employee receives options in a ratio of two for each self-investment, capped at an investment level of €10,000 per program year. The fictitious options are subject to a lock-up period of four years and may be exercised during a subsequent two-year exercise period. The exercise is triggered by the sale of the underlying shares. The payout price is triggered by the price of the share sales in the exercise period. The payout is capped at 500% of the invested amount.

## MEASUREMENT OF FAIR VALUES

The fair value of the share-based payments of the MSP has been measured by using a binomial simulation.

The inputs used in the measurement of the fair values at the grant date and the measurement date of the MSP include market conditions and were as follows. The expected volatility has been based on the historical volatility of the 3-year period to September 30, 2017.

### Input parameters for fair value measurement of MSP

	T_072		
VALUATION DATE	Sept 30, 2017	Sept 30, 2016	Sept 30, 2015
<b>MSP B (2014)</b>			
Fair value	€12.41	€8.72	€8.78
Share price	€76.79	€50.10	€32.25
Expected annual volatility	27.0%	37.0%	31.0%
Expected annual dividend yield	1.00%	1.00%	1.50%
Expected remaining duration (timing of exercise)	1.0 years	2.0 years	3.0 years
Risk-free annual interest rate	(0.76)%	(0.72)%	(0.20)%
Exercise price	€24.82	€24.82	€24.82
<b>MSP A/B (2015)</b>			
Fair value	€14.14	€7.83	–
Share price	€76.79	€50.10	–
Expected annual volatility	32.0%	33.0%	–
Expected annual dividend yield	1.00%	1.00%	–
Expected remaining duration (timing of exercise)	2.0 years	3.0 years	–
Risk-free annual interest rate	(0.73)%	(0.72)%	–
Exercise price	€31.08	€31.08	–
<b>MSP A/B (2016)</b>			
Fair value	€14.12	–	–
Share price	€76.79	–	–
Expected annual volatility	34.0%	–	–
Expected annual dividend yield	1.00%	–	–
Expected remaining duration (timing of exercise)	3.0 years	–	–
Risk-free annual interest rate	(0.63)%	–	–
Exercise price	€48.64	–	–

In the fiscal year 2017 options for the MSP A and B were issued.

**Number of share options**

T\_073

	MSP B (2014)		MSP A/B (2015)		MSP A/B (2016)	
	Number of options	Exercise price	Number of options	Exercise price	Number of options	Exercise price
Outstanding as at October 01, 2014	–	–	–	–	–	–
Granted during the year	19,721	€24.82	–	–	–	–
Forfeited during the year	–	–	–	–	–	–
Exercised during the year	–	–	–	–	–	–
Outstanding as at September 30, 2015	19,721	€24.82	–	–	–	–
Exercisable as at September 30, 2015	–	–	–	–	–	–
Outstanding as at October 01, 2015	19,721	€24.82	–	–	–	–
Granted during the year	–	–	35,911	€31.08	–	–
Forfeited during the year	133	€24.82	916	€31.08	–	–
Exercised during the year	–	–	–	–	–	–
Outstanding as at September 30, 2016	19,588	€24.82	34,995	€31.08	–	–
Exercisable as at September 30, 2016	–	–	–	–	–	–
Outstanding as at October 01, 2016	19,588	€24.82	34,995	€31.08	–	–
Granted during the year	–	–	–	–	27,449	€48.64
Forfeited during the year	–	–	–	–	–	–
Exercised during the year	–	–	–	–	–	–
Outstanding as at September 30, 2017	19,588	€24.82	34,995	€31.08	27,449	€48.64
Exercisable as at September 30, 2017	–	–	–	–	–	–

The Phantom Stock Program is measured by using a binomial stimulation and accrued over the vesting time.

### Input parameters for fair value measurement of PSP

T\_074

VALUATION DATE	Sept 30, 2017	Sept 30, 2016	Sept 30, 2015
<b>Phantom Stock Program 2014/15</b>			
Fair value	€76.28	€49.27	€32.25
Share price	€76.79	€50.10	€32.25
Expected annual dividend yield	1.00%	1.00%	–
Exercise price	–	–	–
<b>Phantom Stock Program 2015/16</b>			
Fair value	€75.52	€48.78	€32.25
Share price	€76.79	€50.10	€32.25
Expected annual dividend yield	1.00%	1.00%	–
Exercise price	–	–	–

### Phantom Stock Program options

T\_075

	Phantom Stock Program 2014/15		Phantom Stock Program 2015/16	
	Number of options	Exercise price	Number of options	Exercise price
Outstanding as at 01 October 2014	–	–	–	–
Granted during the year	5,642	–	3,217	–
Forfeited during the year	–	–	–	–
Exercised during the year	–	–	–	–
Outstanding as at 30 September 2015	5,642	–	3,217	–
Exercisable as at 30 September 2015	–	–	–	–
Outstanding as at 01 October 2015	5,642	–	3,217	–
Granted during the year	–	–	–	–
Forfeited during the year	–	–	–	–
Exercised during the year	–	–	–	–
Outstanding as at 30 September 2016	5,642	–	3,217	–
Exercisable as at 30 September 2016	–	–	–	–
Outstanding as at 01 October 2016	–	–	–	–
Granted during the year	–	–	–	–
Forfeited during the year	–	–	–	–
Exercised during the year	–	–	–	–
Outstanding as at 30 September 2017	–	–	–	–
Exercisable as at 30 September 2017	–	–	–	–

## EXPENSE RECOGNIZED IN PROFIT OR LOSS

An amount of €673 thousand (PY: €200 thousand) was recognized in the related employee benefit expenses and an amount of €1,003 thousand (PY: €330 thousand) in provisions for employee-related expenses.

### 37 Auditor's fees

#### Auditor's fees

T\_076

IN € THOUSANDS (EXCLUDING VAT)	Year ended Sept 30,	
	2017	2016
Audit fees	797	920
<i>Thereof for the prior year</i>	47	–
Audit-related fees	–	732
Tax fees	152	–
Other fees	–	–
<b>Total</b>	<b>949</b>	<b>1,652</b>

For fiscal year ended September 30, 2017, a global fee (excluding VAT) of €797 thousand (PY: €920 thousand) was agreed with the group auditors for the audit of the consolidated and annual financial statements of the Stabilus entities. These fees are included in the Group's administrative expenses.

In addition, KPMG Luxembourg Société cooperative, Luxembourg, and other member firms of the KPMG network, billed audit related fees amounting to €0 thousand (PY: €732 thousand) and tax service fees amounting to €152 thousand (PY: €0 thousand) to the Stabilus Group. Tax services comprise the preparation of tax filings and the provision of tax advice.

### 38 Related party relationships

In accordance with IAS 24, persons or entities that control or are controlled by the Stabilus Group shall be disclosed, unless they are included in consolidation as a consolidated entity.

The disclosure obligation under IAS 24 furthermore extends to transactions with persons who exercise a significant influence on the financial and business policies of the Stabilus Group, including close family members or interposed entrepreneurs. A significant influence on the financial and business policies of the Stabilus Group can hereby be based on a shareholding of 20% or more in Stabilus, a seat on the Management Board of Stabilus or another key position.

## **39 Remuneration of key management personnel**

The key management personnel are the members of the Management Board Dietmar Siemssen (CEO), Mark Wilhelms (CFO), Andreas Schröder (Director Group Financial Reporting) and Andreas Sievers (Director Group Accounting and Strategic Finance Projects).

The total remuneration paid to key management personnel of the Group is calculated as the amount of remuneration paid in cash, benefits in kind and expenses for share-based payments. Benefits in kind primarily comprise the provision of company cars and pensions.

The total remuneration of the above-mentioned key management personnel at the various key Stabilus Group affiliates during the reporting period amounted to €2,710 thousand (PY: €1,975 thousand), thereof €2,434 thousand (PY: €1,865 thousand) is classified as short-term employee benefits, and €276 thousand (PY: €111 thousand) classified as share-based payments.

The compensation of the Management Board members for fiscal year 2017 was split in a fixed compensation of €1,383 thousand (PY: €959 thousand) and a variable compensation of €1,051 thousand (PY: €906 thousand).

The total remuneration to the members of the Supervisory Board amounts to €359 thousand (PY: €365 thousand).

Members of the Management and Supervisory Board have direct interest in Stabilus S. A. of about jointly 0.5% of the total shares.

## **40 Subsequent events**

As of December 13, 2017, there were no further events or developments that could have materially affected the measurement and presentation of Group's assets and liabilities as of September 30, 2017.

Luxembourg, December 13, 2017

Stabilus S. A.  
Management Board



## RESPONSIBILITY STATEMENT

We, Dietmar Siemssen (Chief Executive Officer), Mark Wilhelms (Chief Financial Officer), Andreas Schröder (Director Group Financial Reporting) and Andreas Sievers (Director Group Accounting and Strategic Finance Projects), confirm, to the best of our knowledge, that the consolidated financial statements which have been prepared in accordance with the International Financial Reporting Standards as adopted by the European Union, give a true and fair view of the assets, liabilities, financial position and profit or loss of Stabilus S. A. and the undertakings included in the consolidation taken as a whole and that the management report includes a fair review of the development and performance of the business and the position of Stabilus S. A. and the undertakings included in the consolidation taken as a whole, together with a description of the principal risks and uncertainties that they face.

Luxembourg, December 13, 2017



Dietmar Siemssen  
Management Board



Mark Wilhelms



Andreas Schröder



Andreas Sievers

## MANAGEMENT BOARD OF STABILUS S. A.

### The Management Board comprises four members:

**Dietmar Siemssen** (Chairman) is the Chief Executive Officer and was appointed to the Management Board in 2014 as well as the Chairman of the Management Board. With 20 years of experience in the automotive industry, Mr. Siemssen joined Stabilus in 2011 following a 19-year career in various management positions at Continental AG. He holds a degree in mechanical engineering and business administration. Mr. Siemssen also holds further management positions within the Stabilus Group.

**Mark Wilhelms** is the Chief Financial Officer and was appointed to the Management Board in 2014. With 25 years of experience in the automotive industry, Mr. Wilhelms joined Stabilus in 2009 from FTE Automotive, where he served as Chief Financial Officer for six years. From 2007, he was also head of the NAFTA region at FTE. Prior to that, he held various management positions in finance, plant and marketing at various locations over his 17-year career at Ford. He holds a degree in process engineering as well as a degree in economics. Mr. Wilhelms also holds further management positions within the Stabilus Group.

**Andreas Schröder** is the Group Financial Reporting Director and was appointed to the Management Board in 2014. Mr. Schröder joined Stabilus in 2010. Prior to that, he worked for several years in assurance and advisory business services at Ernst & Young. He holds a degree in business administration. Mr. Schröder also holds further management positions within the Stabilus Group.

**Andreas Sievers** is the Director Group Accounting and Strategic Finance Projects of the Stabilus Group. Mr. Sievers joined Stabilus in 2016. From 2010 to 2015 he worked for the Schaeffler Group as Vice President Accounting Excellence and External Reporting and Vice President Accounting Projects. Prior to that he served as a German and U.S. Certified Public Accountant including positions at PricewaterhouseCoopers AG and Deloitte GmbH. He holds a degree in business administration and passed exams as a U.S and German Certified Public Accountant in 2002 and 2004, respectively. Mr. Sievers also holds further management positions within the Stabilus Group.

## SUPERVISORY BOARD OF STABILUS S. A.

### The Supervisory Board comprises four members:

**Udo Stark** serves as a member of the Supervisory Board since 2014 as well as the Chairman of the Supervisory Board. He was Chairman of the Executive Board of MTU Aero Engines AG until 2007. From 1991 until 2000, Mr. Stark led the listed plant construction and machinery group Agiv AG. Subsequently, he became Chairman of the Shareholder Committee at Messer Griesheim GmbH, Chairman of the Executive Board of mg technologies AG and CEO of MTU Aero Engines AG. From 2008 to 2013, Mr. Stark served as a member of the Supervisory Board of MTU Aero Engines AG. Until May 2016, he was a member of the Supervisory Board of Bilfinger SE and until September 2015 he was the Chairman of the Audit Committee of Bilfinger SE. Until December 2015, he was a member of the Advisory Board of Barmenia Versicherungen and since September 2014, he is Chairman of the Advisory Board of Arvos Group.

**Dr. Stephan Kessel** serves as a member of the Supervisory Board since 2014. He was Chief Executive of Continental AG until 2002. Since then Dr. Kessel has taken up a number of board positions at European companies including Stabilus. From 2008 through 2010, Dr. Kessel was Chairman of the Board of the former holding company of the Operating Stabilus Group. Currently he serves as Chairman on the Boards of Novem Car Interior GmbH and Dayco Products L.L.C.

**Dr. Joachim Rauhut** serves as a member of the Supervisory Board since May 12, 2015. He was a member of the Executive Board of Wacker Chemie AG until October 31, 2015. He joined the Management Board of Wacker-Chemie GmbH in 2001 and supported Wacker Chemie's initial public offering in 2006. Previously, he served in various leading corporate positions, including posts at Mannesmann AG and Krauss-Maffei AG. He is a member of the Supervisory Board of MTU Aero Engines AG and B. Braun Melsungen AG, member of the Advisory Counsel of J. Heinrich Kramer Holding GmbH and member of the Advisory Board of the Region South of COMMERZBANK Aktiengesellschaft.

**Dr. Ralf-Michael Fuchs** serves as a member of the Supervisory Board since 2015. He was member of the Dürr Senior Executive Board and Chief Executive of Division Measuring and Process Systems until 2017. He served as Chairman of the board of various Dürr companies and as Chairman of the management board of Carl SCHENCK AG. Before he joined Dürr AG in 2000, he held various leading positions at IWKA AG and Agiv AG. Since 2004 he is member of the Board of Directors of Nagahama Seisakusho Ltd., Japan.

# INDEPENDENT AUDITOR'S REPORT

To the Shareholders of  
**Stabilus S. A.**  
2, rue Albert Borschette,  
L-1246 Luxembourg

## Report of the réviseur d'entreprises agréé

### REPORT ON THE AUDIT OF THE CONSOLIDATED FINANCIAL STATEMENTS

#### Opinion

We have audited the consolidated financial statements of Stabilus S. A. and its subsidiaries (the "Group"), which comprise the consolidated statement of financial position as at 30 September 2017, and the consolidated statements of comprehensive income, changes in equity and cash flows for the year then ended, and notes to the consolidated financial statements, including a summary of significant accounting policies.

In our opinion, the accompanying consolidated financial statements give a true and fair view of the consolidated financial position of the Group as at 30 September 2017, and of its consolidated financial performance and its consolidated cash flows for the year then ended in accordance with International Financial Reporting Standards (IFRSs) as adopted by the European Union.

#### Basis for opinion

We conducted our audit in accordance with the EU Regulation N° 537/2014, the Law of 23 July 2016 on the audit profession (the "Law of 23 July 2016") and with International Standards on Auditing (ISAs) as adopted for Luxembourg by the "Commission de Surveillance du Secteur Financier" (the "CSSF"). Our responsibilities under those Regulation, Law and standards are further described in the « Responsibilities of "Réviseur d'Entreprises agréé" for the audit of the consolidated financial statements » section of our report. We are also independent of the Group in accordance with the International Ethics Standards Board for Accountants' Code of Ethics for Professional Accountants (the "IESBA Code") as adopted for Luxembourg by the CSSF together with the ethical requirements that are relevant to our audit of the consolidated financial statements, and have fulfilled our other ethical responsibilities under those ethical requirements. We believe that the audit evidence we have obtained is sufficient and appropriate to provide a basis for our opinion.

#### Key audit matters

Key audit matters are those matters that, in our professional judgment, were of most significance in our audit of the consolidated financial statements of the current period. These matters were addressed in the context of the audit of the consolidated financial statements as a whole, and in forming our opinion thereon, and we do not provide a separate opinion on these matters.

## Goodwill

a) Why the matter was considered to be one of most significance in our audit of the consolidated financial statements of the current period?

As at 30 September 2017, the Group's goodwill represents EUR 194,2 million or 20.9% of the Group's total assets.

The Group conducted an impairment assessment of the goodwill on all its cash-generating units ("CGUs") to identify if the recoverable amount is less than the carrying amount.

The Group determined the recoverable amount of CGUs using the "fair value less cost of disposal" model based on discounted cash flow approach considering a business plan with five-year projections and a terminal value. Due to the inherent uncertainty of forecasting, derivation of the discount rate and respective assumptions, e.g. beta factor or market risk premium, the fair value derivation underlies a significant area of judgment and is typically focused by capital market participants.

For CGUs where the difference between fair value less cost of disposal and the carrying amount is relatively small, the risk of a goodwill impairment is generally higher. The risk of a goodwill impairment depends on the CGUs' fair value which is most sensitive to estimates of future cash flows and other key assumptions. Therefore, a risk exists that information disclosed in connection with the goodwill impairment test (e.g. pre-tax WACC, sensitivity calculations) would not be appropriate.

b) How the matter was addressed in our audit

Our procedures included the assessment of the Group's Goodwill impairment-testing process, key controls and the assumptions and financial and capital market data used.

We tested key assumptions forming the Group's fair value less cost of disposal calculations, the cash flow projections and discount rates. We reconciled the managements' future cash flow forecasts to the financial budget approved by the Supervisory Board.

We evaluated the reasonableness of cash flow projections and compared key inputs, such as the discount rates and growth rates, to externally available financial, economic and industry data, and the Group's performance history and accuracy of the forecasting figures retrospectively.

With the assistance of our own valuation specialists, we critically assessed the underlying assumptions and methodologies used to determine the fair values less cost of disposal for those CGUs where significant goodwill was found to be sensitive to changes in those assumptions.

Additionally, we also reconciled the aggregate fair value less cost of disposal of the CGUs determined by the Group to its market capitalization.

We considered whether the Group's disclosures of the application of judgment in estimating key assumptions and the sensitivity of the results of those estimates adequately reflect the risk associated with goodwill impairment.

### Warranty provisions

a) Why the matter was considered to be one of most significance in our audit of the consolidated financial statements of the current period?

As at 30 September 2017, the Group's provision for warranties amounts to EUR 13,0 million or 4.8% of the Group's total operating liabilities (total liabilities without total financial liabilities), respectively 1.4% of total Equity & Liabilities. Warranties are provided as stipulated under each sale contract. The identification and reporting of specific warranty cases have to be handled in a transparent and centralized process supported by the chief council. Specific provisions are assessed and determined by the management based on their experience of the likelihood of claims and risks arising from contracts covered by warranty. This considered the individual circumstances of each case. For contracts that do not specifically indicate any warranty provision, warranties are provided based on a percentage of sales. Determining the amount of both specific and general warranties involves judgement and the uncertainty of the estimates.

b) How the matter was addressed in our audit

In relation to provisions for specific known issues, our procedures include challenging the basis of the Group's calculations by reference to the Group's risk assessment, the status of discussions with the relevant customer (determined by inspecting relevant correspondence) and the cost estimates for rectification work. In performing these procedures we have regard to past experience in addressing such matters.

In relation to unidentified issues, we assess and challenge the Group's methodology for determining the level of provision required taking into account the key assumptions such as historical accuracy of provisioning, the levels of expense incurred over time together with current information on product quality experience. We also assess the adequacy of the Group's disclosures in relation to the significant judgements in relation to warranty provisioning and related contingent liabilities or insurance reimbursements, if relevant.

Our procedures included, amongst others, the assessment of the Group's wide process of reporting of customer complaint and the evaluation of the key assumptions and data applied in determining the Group's warranties provision individually and on lump-sum basis. This included a comparison of the provision for warranties to the historical amounts being utilized, to determine whether the Group's estimation techniques are reasonable.

### Other information

The Management Board is responsible for the other information. The other information comprises the information stated in the annual report including the management report and the Corporate Governance Statement but does not include the consolidated financial statements and our report of "Réviseur d'Entreprises agréé" thereon.

Our opinion on the consolidated financial statements does not cover the other information and we do not express any form of assurance conclusion thereon.

In connection with our audit of the consolidated financial statements, our responsibility is to read the other information and, in doing so, consider whether the other information is materially inconsistent with the consolidated financial statements or our knowledge obtained in the audit or otherwise appears to be materially misstated. If, based on the work we have performed, we conclude that there is a material misstatement of this other information we are required to report this fact. We have nothing to report in this regard.

### **Responsibility of the Management Board and Those Charged with Governance for the consolidated financial statements**

The Management Board is responsible for the preparation and fair presentation of the consolidated financial statements in accordance with IFRSs as adopted by the European Union, and for such internal control as the Management Board determines is necessary to enable the preparation of consolidated financial statements that are free from material misstatement, whether due to fraud or error.

In preparing the consolidated financial statements, the Management Board is responsible for assessing the Group's ability to continue as a going concern, disclosing, as applicable, matters related to going concern and using the going concern basis of accounting unless the Management Board either intends to liquidate the Group or to cease operations, or has no realistic alternative but to do so.

Those charged with governance are responsible for overseeing the Group's financial reporting process.

### **Responsibility of the Réviseur d'Entreprises agréé for the audit of the consolidated financial statements**

The objectives of our audit are to obtain reasonable assurance about whether the consolidated financial statements as a whole are free from material misstatement, whether due to fraud or error, and to issue a report of "Réviseur d'Entreprises agréé" that includes our opinion. Reasonable assurance is a high level of assurance, but is not a guarantee that an audit conducted in accordance with the EU Regulation N° 537/2014, the Law of 23 July 2016 and with ISAs as adopted for Luxembourg by the CSSF will always detect a material misstatement when it exists. Misstatements can arise from fraud or error and are considered material if, individually or in the aggregate, they could reasonably be expected to influence the economic decisions of users taken on the basis of these consolidated financial statements.

As part of an audit in accordance with the EU Regulation N° 537/2014, the Law of 23 July 2016 and with ISAs as adopted for Luxembourg by the CSSF, we exercise professional judgment and maintain professional skepticism throughout the audit. We also:

- Identify and assess the risks of material misstatement of the consolidated financial statements, whether due to fraud or error, design and perform audit procedures responsive to those risks, and obtain audit evidence that is sufficient and appropriate to provide a basis for our opinion. The risk of not detecting a material misstatement resulting from fraud is higher than for one resulting from error, as fraud may involve collusion, forgery, intentional omissions, misrepresentations, or the override of internal control.
- Obtain an understanding of internal control relevant to the audit in order to design audit procedures that are appropriate in the circumstances, but not for the purpose of expressing an opinion on the effectiveness of the Group's internal control.

- Evaluate the appropriateness of accounting policies used and the reasonableness of accounting estimates and related disclosures made by the Management Board.
- Conclude on the appropriateness of Management Board's use of the going concern basis of accounting and, based on the audit evidence obtained, whether a material uncertainty exists related to events or conditions that may cast significant doubt on the Group's ability to continue as a going concern. If we conclude that a material uncertainty exists, we are required to draw attention in our report of "Réviseur d'Entreprises agréé" to the related disclosures in the consolidated financial statements or, if such disclosures are inadequate, to modify our opinion. Our conclusions are based on the audit evidence obtained up to the date of report of "Réviseur d'Entreprises agréé". However, future events or conditions may cause the Group to cease to continue as a going concern.
- Evaluate the overall presentation, structure and content of the consolidated financial statements, including the disclosures, and whether the consolidated financial statements represent the underlying transactions and events in a manner that achieves fair presentation.
- Obtain sufficient appropriate audit evidence regarding the financial information of the entities and business activities within the Group to express an opinion on the consolidated financial statements. We are responsible for the direction, supervision and performance of the Group audit. We remain solely responsible for our audit opinion.

We communicate with those charged with governance regarding, among other matters, the planned scope and timing of the audit and significant audit findings, including any significant deficiencies in internal control that we identify during our audit.

We also provide those charged with governance with a statement that we have complied with relevant ethical requirements regarding independence, and to communicate with them all relationships and other matters that may reasonably be thought to bear on our independence, and where applicable, related safeguards.

From the matters communicated with those charged with governance, we determine those matters that were of most significance in the audit of the consolidated financial statements of the current period and are therefore the key audit matters. We describe these matters in our report unless law or regulation precludes public disclosure about the matter or when, in extremely rare circumstances, we determine that a matter should not be communicated in our report because the adverse consequences of doing so would reasonably be expected to outweigh the public interest benefits of such communication.

## REPORT ON OTHER LEGAL AND REGULATORY REQUIREMENTS

We have been appointed as "Réviseur d'Entreprises agréé" by the Annual General Meeting of the Shareholders on 15 February 2017 and the duration of our uninterrupted engagement, including previous renewals and reappointments, is four years.

The management report is consistent with the consolidated financial statements and has been prepared in accordance with applicable legal requirements.

The Corporate Governance Statement is included in the management report. The information required by Article 68bis paragraph (1) letters c) and d) of the law of 19 December 2002 on the commercial and



companies register and on the accounting records and annual accounts of undertakings, as amended, is consistent with the consolidated financial statements and has been prepared in accordance with applicable legal requirements.

We confirm that the audit opinion is consistent with the additional report to the audit committee or equivalent.

We confirm that the prohibited non-audit services referred to in the EU Regulation No 537/2014, on the audit profession were not provided and that we remain independent of the Group in conducting the audit.

#### **OTHER MATTER**

The Corporate Governance Statement includes, when applicable, information required by Article 68bis paragraph (1) points a), b), e), f) and g) of the law of 19 December 2002 on the commercial and companies register and on the accounting records and annual accounts of undertakings, as amended.

Luxembourg, December 13, 2017

KPMG Luxembourg Société coopérative  
Cabinet de révision agréé  
T. Feld



# ANNUAL **ACCOUNTS**



CHAPTER

**D**

139 - 156

## BALANCE SHEET

as of September 30, 2017

### Balance sheet

T\_077

IN € THOUSANDS	NOTE	Sept 30, 2017	Sept 30, 2016
<b>Assets</b>			
<b>Fixed assets</b>	3	<b>628,451</b>	<b>461,744</b>
Intangible assets			
Concessions, patents, licenses, trade marks and similar rights and assets, if they were acquired for valuable consideration and need not be shown under C.I.3		1	9
Tangible assets			
Other fixtures and fittings, tools and equipment		6	20
Financial assets			
Shares in affiliated undertakings	4	628,444	461,715
<b>Current assets</b>		<b>965</b>	<b>161,108</b>
Debtors	5	643	160,746
Amounts owed by affiliated undertakings			
becoming due and payable within one year		186	160,547
Other debtors			
becoming due and payable within one year		458	199
Cash at bank and in hand		322	362
<b>Prepayments</b>	6	<b>348</b>	<b>441</b>
<b>Total assets</b>		<b>629,764</b>	<b>623,293</b>

## Balance sheet

T\_077

IN € THOUSANDS	NOTE	Sept 30, 2017	Sept 30, 2016
<b>Liabilities</b>			
<b>Capital and reserves</b>	7	<b>619,935</b>	<b>602,426</b>
Subscribed capital		247	247
Share premium account		419,801	419,801
Reserves			
Legal reserve		21	21
Other reserves, including the fair value reserve		4,836	4,836
Profit or loss brought forward		165,171	185,281
Profit or loss for the financial year		29,860	(7,759)
<b>Provisions</b>		<b>810</b>	<b>800</b>
Provisions for taxation		810	800
<b>Creditors</b>		<b>9,018</b>	<b>20,067</b>
Trade creditors			
becoming due and payable within one year		695	2,374
Amounts owed to affiliated undertakings			
becoming due and payable within one year	8	7,499	17,009
Other creditors			
Tax authorities			
Social security authorities		11	10
Other creditors			
becoming due and payable within one year		813	674
<b>Total liabilities</b>		<b>629,764</b>	<b>623,293</b>

## PROFIT AND LOSS ACCOUNT

for the fiscal year ended September 30, 2017

### Profit and loss account

T\_078

IN € THOUSANDS	NOTE	Year ended Sept 30,	
		2017	2016
<b>Other operating income</b>	9	<b>3,496</b>	<b>12,872</b>
<b>Raw materials and consumables and other external expenses</b>	10	<b>(2,145)</b>	<b>(18,960)</b>
Other external expenses		(2,145)	(18,960)
<b>Staff costs</b>	11	<b>(722)</b>	<b>(906)</b>
Wages and salaries		(644)	(547)
Social security on salaries and wages		(78)	(359)
<b>Value adjustments</b>	3	<b>(22)</b>	<b>(22)</b>
in respect of formation expenses and tangible and intangible fixed assets		(22)	(22)
<b>Other operating expenses</b>		<b>(477)</b>	<b>(1,291)</b>
<b>Income from participating interests</b>	12	<b>47,211</b>	–
derived from affiliated undertakings		47,211	–
<b>Other interest receivable and similar income</b>		–	<b>689</b>
derived from affiliated undertakings		–	689
<b>Value adjustments and fair value adjustments on financial current assets</b>	13	<b>(17,236)</b>	<b>(59)</b>
<b>Interest payable and similar expenses</b>		<b>(66)</b>	<b>(81)</b>
concerning affiliated undertakings		–	–
Other interest and similar financial expenses		(66)	(81)
<b>Tax on profit or loss</b>		<b>(179)</b>	<b>(2)</b>
<b>Profit or loss after taxation</b>		<b>29,860</b>	<b>(7,759)</b>

# NOTES TO THE ANNUAL ACCOUNTS

for the year ended September 30, 2017

## 1 General

Stabilus S. A., Luxembourg, hereafter also referred to as “Stabilus” or the “Company” is a public limited liability company (société anonyme) incorporated in Luxembourg and governed by Luxembourg law. The registered office of the Company is 2, rue Albert Borschette, L-1246 Luxembourg, Grand Duchy of Luxembourg. The trade register number is B0151589. The Company was founded under the name of Servus HoldCo S. à r. l. on February 26, 2010.

The Company is managed by a Management Board under the supervision of the Supervisory Board.

The Company is formed for an unlimited duration.

The purpose of the Company is (i) the acquisition, holding and disposal, in any form, by any means, whether directly or indirectly, of participations, rights and interests in, and obligations of, Luxembourg and foreign companies, including but not limited to any entities forming part of the Stabilus group, (ii) the acquisition by purchase, subscription, or in any other manner, as well as the transfer by sale, exchange or in any other manner of stock, bonds, debentures, notes and other securities or financial instruments of any kind (including notes or parts or units issued by Luxembourg or foreign mutual funds or similar undertakings) and receivables, claims or loans or other credit facilities and agreements or contracts relating thereto, and (iii) the ownership, administration, development and management of a portfolio of assets (including, among other things, the assets referred to in (i) and (ii) above).

The Company’s financial year starts on October 1 and ends on September 30 each year.

The Company has no parent company which prepares consolidated financial statements including the Company as a subsidiary.

The Company prepares consolidated financial statements in accordance with EU regulation 1606/2002.

The copies of the consolidated financial statements are available at the registered office of the Company at 2, rue Albert Borschette, L-1246 Luxembourg or on [www.stabilus.com](http://www.stabilus.com).

## **2 Summary of significant valuation and accounting policies**

### **BASIS OF PRESENTATION**

The annual accounts are prepared in accordance with Luxembourg company law and generally accepted accounting principles applicable in Luxembourg. The accounting policies and valuation principles are, apart from those enforced by law, determined by the Management Board.

The annual accounts have been prepared on a going concern basis and in accordance with current legal requirements and generally accepted accounting principles in the Grand Duchy of Luxembourg.

By adopting the law of December 18, 2015, amending the Commercial Code of August 10, 2015 and the law of December 19, 2002, the structure and headings of the balance sheet and of the profit or loss account have been changed. Some comparative figures have been changed accordingly.

### **FOREIGN CURRENCY TRANSLATION**

The Company maintains its books and records in euro (€). The balance sheet and the profit and loss account are expressed in this currency.

Formation expenses, intangible, tangible and financial fixed assets denominated in currencies other than € are translated at the historical exchange rates.

Cash at bank denominated in currencies other than € are translated at the exchange rates prevailing at the date of the balance sheet.

Current assets and liabilities denominated in currencies other than € (having an economic link and similar characteristics) are recorded globally at the exchange rates prevailing at the date of the balance sheet.

Long term debts denominated in currencies other than € having an economic link with receivables recorded in financial assets (and having similar characteristics) are translated at the historical exchange rates (loans "back to back").

As a result, realized exchange gains and losses and unrealized exchange losses are recorded in the profit and loss account. Unrealized exchange gains are not recognized.

### **INTANGIBLE AND TANGIBLE ASSETS**

Intangible and tangible assets are used for business purposes and are measured at cost less accumulated value adjustments. Depreciation on intangible and tangible assets is recorded on a straight-line basis in accordance with its utilization and based on the useful life of the asset. The residual value, depreciation methods and useful life are reviewed annually and adjusted, if necessary.

## **FINANCIAL ASSETS**

Shares in affiliated undertakings, participating interests and securities held as fixed assets are stated at acquisition cost. Write-downs are recorded if a permanent reduction in the fair value is expected. The impairment analysis is done individually for each investment.

Loans to affiliated undertakings are recorded at their nominal value. Loans are written down to their recoverable amount if there is a permanent impairment.

These value adjustments may not be continued if the reasons for which the value adjustments were recognized have ceased to exist.

## **DEBTORS**

Current receivables are recorded at their nominal value. Current receivables are written down to their recoverable amount if there is a permanent impairment.

These value adjustments may not be continued if the reasons for which the value adjustments were recognized have ceased to exist.

## **PROVISIONS**

Provisions are intended to cover losses or debts, the nature of which is clearly defined and which, at the date of the balance sheet, are either likely to be incurred or certain to be incurred but uncertain as to their amount or the date on which they will arise.

## **CREDITORS**

Debts are recorded at their reimbursement value. Where the amount repayable on account is exceeding the amount received, the difference is shown as an asset and is written off over the period of the debt.



### 3 Movements in fixed assets

#### Fixed assets schedule

T\_079

IN € THOUSANDS	Intangible assets	Tangible assets	Shares in affiliated undertakings	Total
<b>Gross value</b>				
<b>Balance as of Sept 30, 2016</b>	<b>22</b>	<b>44</b>	<b>461,715</b>	<b>461,781</b>
Additions	–	–	628,416	628,416
Disposals	–	–	(461,687)	(461,687)
<b>Balance as of Sept 30, 2017</b>	<b>22</b>	<b>44</b>	<b>628,444</b>	<b>628,510</b>
<b>Accumulated value adjustments</b>				
<b>Balance as of Sept 30, 2016</b>	<b>(13)</b>	<b>(24)</b>	–	<b>(37)</b>
Additions	(8)	(14)	–	(22)
Disposals	–	–	–	–
<b>Balance as of Sept 30, 2017</b>	<b>(21)</b>	<b>(38)</b>	–	<b>(59)</b>
<b>Carrying amount</b>				
<b>Balance as of Sept 30, 2016</b>	<b>9</b>	<b>20</b>	<b>461,715</b>	<b>461,744</b>
<b>Balance as of Sept 30, 2017</b>	<b>1</b>	<b>6</b>	<b>628,444</b>	<b>628,451</b>

### 4 Financial assets

#### Shares in affiliated undertakings

T\_080

IN € THOUSANDS	Proportion of capital held	Year end date	Shares in affiliated undertakings as at Sept 30, 2017	Equity as at year end (including result)	Profit or loss for the year ended
Blitz F10 neun GmbH i. L., Waltersheimer Weg 100, 56070 Koblenz, Germany	100%	31.12.2016	28	(13)	(23)
Servus III (Gibraltar) Limited, 57/63 Line Wall Road, Gibraltar	100%	30.09.2016	–	6,046	964
Stable II S.à r. l., 2, rue Albert Borschette, 1246 Luxembourg, Luxembourg	100%	30.09.2016	628,416	382,631	5,477
<b>Total</b>			<b>628,444</b>		

In fiscal year 2017, the Stabilus Group simplified its legal structure. In this context, the Company's previously held subsidiaries Servus Sub S.à r. l. and Servus Luxembourg S.à r. l. were dissolved leading to a disposal of € 456,525 thousand. All assets and liabilities held by Servus Sub S.à r. l. and Servus

Luxembourg S.à r. l. were transferred to Stabilus comprising among others the 94.9% share held in Stable II S. à r. l. In addition the Company purchased the remaining 5.1% share in Stable II S. à r. l. for €54,199 thousand.

The Company also increased its investment in Stable II S. à r. l. by contributing an amount of €149,634 thousand in kind with effect from October 1, 2016 to the capital surplus account of Stable II S. à r. l. Parts of the capital surplus account of Stable II S. à r. l. have been repaid with a net effect of €18,466 thousand. As of September 30, 2017, Stabilus holds 100% of the shares in Stable II S. à r. l.

The investment in Servus III (Gibraltar) Limited as per September 30, 2016 of € 5,162 thousand is reduced to €0 thousand in September 2017 due to a repayment of the capital reserve of Servus III (Gibraltar) Limited amounting to € 4,224 thousand (see note 12) and a transfer of the net assets of Servus III (Gibraltar) Limited as final liquidation distribution in kind.

Blitz F10 neun GmbH i. L. and Servus III (Gibraltar) Limited are inactive and in the process of final liquidation.

## **5 Debtors**

### **5.1 AMOUNTS OWED BY AFFILIATED UNDERTAKINGS**

The amount of €186 thousand is a receivable from affiliated undertakings for providing management services. The majority of prior year receivables owed by affiliated undertakings, substantially related to cash pool receivables, was contributed into the capital surplus account of Stable II S. à r. l. as contribution in kind.

### **5.2 OTHER DEBTORS**

The amount mainly consists of a VAT receivable (€449 thousand).

## **6 Prepayments**

Prepayments mainly relate to insurance contracts.

## **7 Capital and reserves**

Issued capital as of September 30, 2017 amounted to €247 thousand (September 30, 2016 €247 thousand) and was fully paid in. It is divided into 24,700,000 shares each with a nominal value of €0.01. The authorized capital of the Company is set at €315 thousand represented by a maximum of 31.5 million shares, each with nominal value of €0.01.

The Annual General Meeting on February 15, 2017 approved the distribution of a dividend of €0.50 per share with a total amount of € 12,350 thousand out of profit brought forward and to set off the loss from fiscal year 2016 amounting to €7,759 thousand from profit brought forward.

Under Luxembourg law, the Company is required to allocate annually at least 5% of its statutory net profit to a legal reserve until the aggregate reserve equals 10% of the subscribed share capital. The reserve is not available for distribution. In financial year 2017, no additional amount was allocated to the legal reserve.

## **8** Amounts owed to affiliated undertakings

The amount of €7,499 thousand (PY: €17,009 thousand) consists of cash pool liabilities owed to affiliated undertakings.

## **9** Other operating income

The other operating income mainly includes reimbursements for management services provided by Stabilus S. A. to other Stabilus Group companies amounting to €3,488 thousand (PY: €2,304 thousand). In fiscal year 2016, the other operating income also included €10,300 thousand reimbursements of refinancing and acquisition cost.

## **10** Other external expenses

### Other external expenses

T\_081

IN € THOUSANDS	Year ended Sept 30,	
	2017	2016
Administration fees	296	133
Consulting fees	1,038	17,978
Audit fees	361	396
Group insurance	172	207
Legal and professional fees	233	228
Bank charges	45	17
<b>Total</b>	<b>2,145</b>	<b>18,959</b>

## **11** Staff costs

The Company employs 7 employees as of September 30, 2017 (PY: 5). The average number of employees in the financial year 2017 was 6 (PY: 5).

## **12** Income from participating interests

In February 2017, Servus III (Gibraltar) Limited distributed a dividend in kind to its sole shareholder Stabilus S. A. with an amount of €51,435 thousand. Thereof €47,211 thousand relates to the distribution of retained earnings of Servus III (Gibraltar) Limited and is recognized in income from participating interests. The remaining €4,224 thousand are mainly a repayment of the capital reserve of Servus III and as such reduce the investment in Servus III (Gibraltar) Limited.

### **13 Value adjustments in respect of financial assets and of investments held as current assets**

The value adjustments in respect of financial assets and of investments held as current assets substantially comprise the result of the simplified dissolution without liquidation of the former subsidiaries Servus Sub S. à r. l. and Servus Luxembourg S. à r. l. in May 2017. The net assets of these two entities have been transferred to Stabilus S. A., and the investments have been derecognized. The difference between the net assets received and the investment is recognized as a value adjustment in respect of financial assets with an amount of €17,147 thousand.

### **14 Taxation**

The Company is subject to Luxembourg company tax law.

### **15 Related parties**

The remuneration of the members of the Management Board amounts to €353 thousand (PY: €343 thousand). The remuneration of the members of the Supervisory Board amounts to €359 thousand (PY: €365 thousand).

As of September 30, 2017, members of the Management and Supervisory Board held about 0.5% of the total shares in Stabilus S. A.

### **16 Share-based payments**

The variable compensation for the members of the Management Board includes a matching stock program. The matching stock program (the "MSP") provides for four annual tranches granted each year during the financial year ending September 30, 2014 until September 30, 2017. Participation in the matching stock program requires Management Board members to invest in shares of the Company. The investment has generally to be held for the lock-up period.

As part of the matching stock program A (the "MSP A") for each share the Management Board invests in the Company in the specific year (subject to general cap), the Management Board members receive a certain number of fictitious options to acquire shares in the Company for each tranche of the matching stock program. The amount of stock options received depends upon a factor to be set by the Supervisory Board (Remuneration Committee) annually in a range between 1.0 time and 1.7 times for a certain tranche. Thus, if a Management Board member were to buy 1,000 shares under the MSP A in the Company, he would receive 1,000 to 1,700 fictitious options for a certain tranche. The fictitious options are subject to a lock-up period of four years and may be exercised during a subsequent two-year exercise period.

As part of matching stock program B (the "MSP B") for each share the Management Board holds in the Company in the specific year (subject to a general cap), the Management Board members receive a certain number of fictitious options to acquire shares in the Company for each tranche of the matching stock program. The amount of stock options received depends upon a factor to be set by the Supervisory

Board (Remuneration Committee) annually which will be in a range between 0.0 and 0.3 times for a certain tranche. Thus, if a Management Board member were to be holding 1,000 shares under the MSP B in the Company, he would receive 0 to 300 fictitious options for a certain tranche.

The fictitious options are subject to a lock-up period of four years and may be exercised during a subsequent two-year exercise period. The options may only be exercised if the stock price of the Company exceeds a set threshold for the relevant tranche, which the Supervisory Board will determine at the time of granting the options, and which needs to be between 10% and 50% growth over the base price, which is the share price on the grant date. If exercised, the fictitious options are transformed into a gross amount equaling the difference between the option price and the relevant stock price multiplied by the number of exercised options. The Company plans a cash settlement. The maximum gross amounts resulting from the exercise of the fictitious options of one tranche in general is limited in amount to 50% of the base price. Reinvestment of IPO proceeds from previous equity programs are not taken into account for MSP A. In fiscal year 2017, 12,418 options were issued for MSP A and 15,031 for MSP B. The exercise price is €48.64.

## **17 Commitments, contingencies and pledges**

In fiscal year 2016, the Company and other affiliated companies entered into a senior term loan facility with a total amount of €640,000 thousand made up of a €455,000 thousand senior A facility, an equity bridge facility commitment of €115,000 thousand and a €70,000 thousand revolving facility. The equity bridge facility commitment has already been repaid per September 30, 2016. The original term of the senior term loan was June 29, 2021 and was extended to June 29, 2022 in August 2017. The Company is guarantor of the senior term loan facility.

In relation with the simplification of the Group structure the Company became sole owner of 100% shares in Stable II S.à r. l. and the sole pledgor in accordance with the Confirmation Transfer and Amendment Agreement dated May 16, 2017 under the Share Pledge Agreement dated January 27, 2017.

The Company has signed a rent contract for its office starting November 1, 2013 and terminating January 31, 2018. The rental payments for the financial year 2018 will be €57 thousand. On November 20, 2017 the rent contract has been extended until October 31, 2019.

The Company issued a bank guarantee amounting to €100 thousand for the above mentioned office lease.

## **18 Subsequent events**

There were no events or developments that could have materially affected the measurement and presentation of the Company's assets and liabilities as of September 30, 2017.

# INDEPENDENT AUDITOR'S REPORT

To the Shareholders of  
**Stabilus S. A.**  
2, rue Albert Borschette,  
L-1246 Luxembourg

## Report of the réviseur d'entreprises agréé

### REPORT ON THE AUDIT OF THE ANNUAL ACCOUNTS

#### Opinion

We have audited the annual accounts of Stabilus S.A. (the "Company"), which comprise the balance sheet as at 30 September 2017, and the profit and loss account for the year then ended, and notes to the annual accounts, including a summary of significant accounting policies.

In our opinion, the accompanying annual accounts give a true and fair view of the financial position of the Company as at 30 September 2017, and of the results of its operations for the year then ended in accordance with Luxembourg legal and regulatory requirements relating to the preparation and presentation of the annual accounts.

#### Basis for Opinion

We conducted our audit in accordance with the EU Regulation N° 537/2014, the Law of 23 July 2016 on the audit profession ("Law of 23 July 2016") and with International Standards on Auditing ("ISAs") as adopted for Luxembourg by the "Commission de Surveillance du Secteur Financier" ("CSSF"). Our responsibilities under those Regulation, Law and standards are further described in the « Responsibilities of "Réviseur d'Entreprises agréé" for the audit of the annual accounts » section of our report. We are also independent of the Company in accordance with the International Ethics Standards Board for Accountants' Code of Ethics for Professional Accountants ("IESBA Code") as adopted for Luxembourg by the CSSF together with the ethical requirements that are relevant to our audit of the annual accounts, and have fulfilled our other ethical responsibilities under those ethical requirements. We believe that the audit evidence we have obtained is sufficient and appropriate to provide a basis for our opinion.

#### Key audit matters

Key audit matters are those matters that, in our professional judgment, were of most significance in our audit of the annual accounts of the current period. These matters were addressed in the context of the audit of the annual accounts as a whole, and in forming our opinion thereon, and we do not provide a separate opinion on these matters.

### **Group restructuring**

a) Why the matter was considered to be one of most significance in our audit of the annual accounts of the current period?

Refer to note 4 of the annual accounts. We identified the group restructuring as a key audit matter as related transactions required audit focus due to the magnitude of transactions.

Transactions subject to audit focus were:

- Dissolution of subsidiaries including transfer of all assets and liabilities previously held by the dissolved subsidiaries to the Company;
- Increase of the carrying amount for financial assets by a contribution in kind of a receivable of €149,634 thousand with effect from 1 October 2016 to the capital surplus account of Stable II S.à r. l., partly offset by repayment of €18,466 thousand,
- Acquisition of remaining 5.1% share in Stable II S.à r. l. for €54,199 thousand.

b) How the matter was addressed in our audit

We obtained and inspect the key supporting documentation such as minutes and resolutions taken to resolve and approve the transactions, Sales and Purchase Agreement and other supporting information.

For each transaction, we understood the nature of the transaction and assessed the proposed accounting treatment in relation to the Company's accounting policies and Luxembourg legal and regulatory requirements.

We involved our tax specialist to evaluate potential tax risks in the context of the dissolution of the subsidiaries including transfer of all assets and liabilities to the Company.

Consideration in relation to the acquisition was agreed with the settlement of the purchase price with intercompany balances, and transferred assets and liabilities as per closing balance sheet of the subsidiaries were reconciled to the accounts of the Company.

### **Other information**

The Management Board is responsible for the other information. The other information comprises the information stated in the annual report including the management report and the Corporate Governance Statement but does not include the annual accounts and our report of "Réviseur d'Entreprises agréé" thereon.

Our opinion on the annual accounts does not cover the other information and we do not express any form of assurance conclusion thereon.

In connection with our audit of the annual accounts, our responsibility is to read the other information and, in doing so, consider whether the other information is materially inconsistent with the annual accounts or our knowledge obtained in the audit or otherwise appears to be materially misstated. If, based on the work we have performed, we conclude that there is a material misstatement of this other information we are required to report this fact. We have nothing to report in this regard.

### **Responsibility of the Management Board and Those Charged with Governance for the annual accounts**

The Management Board is responsible for the preparation and fair presentation of the annual accounts in accordance with Luxembourg legal and regulatory requirements relating to the preparation and presentation of the annual accounts, and for such internal control as the Management Board determines is necessary to enable the preparation of annual accounts that are free from material misstatement, whether due to fraud or error.

In preparing the annual accounts, the Management Board is responsible for assessing the Company's ability to continue as a going concern, disclosing, as applicable, matters related to going concern and using the going concern basis of accounting unless the Management Board either intends to liquidate the Company or to cease operations, or has no realistic alternative but to do so.

Those charged with governance are responsible for overseeing the Group's financial reporting process.

### **Responsibility of the Réviseur d'Entreprises agréé for the audit of the annual accounts**

The objectives of our audit are to obtain reasonable assurance about whether the annual accounts as a whole are free from material misstatement, whether due to fraud or error, and to issue a report of "Réviseur d'Entreprises agréé" that includes our opinion. Reasonable assurance is a high level of assurance, but is not a guarantee that an audit conducted in accordance with the EU Regulation N° 537/2014, the Law of 23 July 2016 and with ISAs as adopted for Luxembourg by the CSSF will always detect a material misstatement when it exists. Misstatements can arise from fraud or error and are considered material if, individually or in the aggregate, they could reasonably be expected to influence the economic decisions of users taken on the basis of these annual accounts.

As part of an audit in accordance with the EU Regulation N° 537/2014, the Law of 23 July 2016 and with ISAs as adopted for Luxembourg by the CSSF, we exercise professional judgment and maintain professional skepticism throughout the audit. We also:

- Identify and assess the risks of material misstatement of the annual accounts, whether due to fraud or error, design and perform audit procedures responsive to those risks, and obtain audit evidence that is sufficient and appropriate to provide a basis for our opinion. The risk of not detecting a material misstatement resulting from fraud is higher than for one resulting from error, as fraud may involve collusion, forgery, intentional omissions, misrepresentations, or the override of internal control.
- Obtain an understanding of internal control relevant to the audit in order to design audit procedures that are appropriate in the circumstances, but not for the purpose of expressing an opinion on the effectiveness of the Company's internal control.
- Evaluate the appropriateness of accounting policies used and the reasonableness of accounting estimates and related disclosures made by the Management Board.
- Conclude on the appropriateness of Management Board's use of the going concern basis of accounting and, based on the audit evidence obtained, whether a material uncertainty exists related to events or conditions that may cast significant doubt on the Company's ability to continue as a going concern. If we conclude that a material uncertainty exists, we are required to draw attention in our report of "Réviseur d'Entreprises agréé" to the related disclosures in the annual accounts or, if such



disclosures are inadequate, to modify our opinion. Our conclusions are based on the audit evidence obtained up to the date of our report of “Réviseur d’Entreprises agréé”. However, future events or conditions may cause the Company to cease to continue as a going concern.

- Evaluate the overall presentation, structure and content of the annual accounts, including the disclosures, and whether the annual accounts represent the underlying transactions and events in a manner that achieves fair presentation.

We communicate with those charged with governance regarding, among other matters, the planned scope and timing of the audit and significant audit findings, including any significant deficiencies in internal control that we identify during our audit.

We also provide those charged with governance with a statement that we have complied with relevant ethical requirements regarding independence, and to communicate with them all relationships and other matters that may reasonably be thought to bear on our independence, and where applicable, related safeguards.

From the matters communicated with those charged with governance, we determine those matters that were of most significance in the audit of the annual accounts of the current period and are therefore the key audit matters. We describe these matters in our report unless law or regulation precludes public disclosure about the matter or when, in extremely rare circumstances, we determine that a matter should not be communicated in our report because the adverse consequences of doing so would reasonably be expected to outweigh the public interest benefits of such communication.

## **REPORT ON OTHER LEGAL AND REGULATORY REQUIREMENTS**

We have been appointed as “Réviseur d’Entreprises agréé” by the Annual General Meeting of the Shareholders on 15 February 2017 and the duration of our uninterrupted engagement, including previous renewals and reappointments, is four years.

The management report is consistent with the annual accounts and has been prepared in accordance with applicable legal requirements.

The Corporate Governance Statement is included in the management report. The information required by Article 68bis paragraph (1) letters c) and d) of the law of 19 December 2002 on the commercial and companies register and on the accounting records and annual accounts of undertakings, as amended, is consistent with the annual accounts and has been prepared in accordance with applicable legal requirements.

We confirm that the audit opinion is consistent with the additional report to the audit committee or equivalent.

We confirm that the prohibited non-audit services referred to in the EU Regulation No 537/2014, on the audit profession were not provided and that we remain independent of the Company in conducting the audit.

## **OTHER MATTER**

The Corporate Governance Statement includes, when applicable, information required by Article 68bis paragraph (1) points a), b), e), f) and g) of the law of 19 December 2002 on the commercial and companies register and on the accounting records and annual accounts of undertakings, as amended.

Luxembourg, December 13, 2017

KPMG Luxembourg Société coopérative  
Cabinet de révision agréé  
T. Feld







# ADDITIONAL **INFORMATION**



CHAPTER

**E**

157 - 161

# FINANCIAL CALENDAR

## Financial calendar

T\_082

DATE <sup>1)2)</sup>	PUBLICATION / EVENT
December 15, 2017	Publication of full year results for fiscal year 2017 (Annual Report 2017)
February 5, 2018	Publication of the first-quarter results for fiscal year 2018 (Interim Report Q1 FY18)
February 14, 2018	Annual General Meeting
May 7, 2018	Publication of the second-quarter results for fiscal year 2018 (Interim Report Q2 FY18)
August 6, 2018	Publication of the third-quarter results for fiscal year 2018 (Interim Report Q3 FY18)
November 16, 2018	Publication of preliminary financial results for fiscal year 2018
December 14, 2018	Publication of full year results for fiscal year 2018 (Annual Report 2018)

<sup>1)</sup> We cannot rule out changes of dates. We recommend checking them on our website in the Investor Relations/ Financial Calendar section ([www.ir.stabilus.com](http://www.ir.stabilus.com)).

<sup>2)</sup> Please note that our fiscal year (FY) comprises a twelve-month period from October 1 to September 30 of the following calendar year. e.g. the fiscal year 2018 comprises a year ended September 30, 2018.

## DISCLAIMER

### Forward-looking statements

This annual report contains forward-looking statements that relate to the current plans, objectives, forecasts and estimates of the management of Stabilus S.A. These statements take into account only information that was available up and including the date that this annual report was prepared. The management of Stabilus S.A. makes no guarantee that these forward-looking statements will prove to be right. The future development of Stabilus S.A. and its subsidiaries and the results that are actually achieved are subject to a variety of risks and uncertainties which could cause actual events or results to differ significantly from those reflected in the forward-looking statements. Many of these factors are beyond the control of Stabilus S.A. and its subsidiaries and therefore cannot be precisely predicted. Such factors include, but are not limited to, changes in economic conditions and the competitive situation, changes in the law, interest rate or exchange rate fluctuations, legal disputes and investigations, and the availability of

funds. These and other risks and uncertainties are set forth in the combined management report. However, other factors could also have an adverse effect on our business performance and results. Stabilus S.A. neither intends to nor assumes any separate obligation to update forward-looking statements or to change these to reflect events or developments that occur after the publication of this annual report.

### Rounding

Certain numbers in this annual report have been rounded up or down. There may therefore be discrepancies between the actual totals of the individual amounts in the tables and the totals shown as well as between the numbers in the tables and the numbers given in the corresponding analyses in the text of the annual report. All percentage changes and key figures in the combined management report were calculated using the underlying data in millions of euros to one decimal place (€ millions).



## TABLE DIRECTORY

DESCRIPTION	NUMBER	PAGE
Latest growth projections for selected economies	01	40
Production of light vehicles	02	40
Income statement	03	41
Revenue by region	04	42
Revenue by markets	05	42
Reconciliation of EBIT to adjusted EBIT	06	44
Operating segments	07	45
Balance sheet	08	46
Cash flows	09	48
Free cash flow	10	49
Adjusted FCF	11	49
Net leverage ratio	12	50
Consolidated statement of comprehensive income	13	63
Consolidated statement of financial position	14	64
Consolidated statement of changes in equity	15	66
Consolidated statement of cash flows	16	67
Subsidiaries	17	71
Exchange rates	18	73
New standards, interpretations and amendments in the financial year	19	74
Standards and interpretations issued and endorsed by the EU (not yet adopted)	20	74
Standards and interpretations issued but not yet endorsed by the EU	21	77
Revenue by region	22	86
Revenue by markets	23	86
Expenses by function	24	87
Personnel expenses	25	87
Number of employees	26	88
Other income	27	88
Other expenses	28	88
Finance income	29	89
Finance costs	30	89
Income tax expense	31	90
Tax expense reconciliation (expected to actual)	32	90
Deferred tax assets and liabilities	33	91
Tax loss and interest carry-forwards	34	92
Weighted average number of shares	35	93
Earnings per share	36	93
Property, plant and equipment	37	94
Depreciation expense for property, plant and equipment	38	95
Goodwill sensitivity analysis	39	96
Intangible assets	40	97
Amortization expense for intangible assets	41	98
Other financial assets	42	98
Other assets	43	99
Inventories	44	99
Trade accounts receivable	45	100
Allowance for doubtful accounts	46	100
Other comprehensive income / (expense)	47	102

DESCRIPTION	NUMBER	PAGE
Financial liabilities	48	103
Other financial liabilities	49	104
Provisions	50	104
Changes of non-current provisions	51	105
Changes of current provisions	52	106
Pension plans and similar obligations	53	107
Unfunded status	54	108
Present value of defined benefit obligations	55	108
Pension cost for defined benefit plans	56	108
Present value of the defined benefit obligation and the experience adjustments on the plan liabilities	57	109
Significant factors for the calculation of pension obligations	58	109
Other liabilities	59	111
Operating lease	60	111
Finance lease	61	112
Financial commitments	62	114
Financial instruments	63	114
Financial instruments	64	115
Credit risks included in financial assets	65	117
Liquidity outflows for liabilities	66	118
Equity ratio	67	119
Segment reporting	68	121
Reconciliation of the total segments' profit to profit/(loss) before income tax	69	122
Geographical information: Revenue by country	70	122
Geographical information: Non-current assets by country	71	123
Input parameter for fair value measurement of MSP	72	125
Number of share options	73	126
Input parameters for fair value measurement of PSP	74	127
Phantom Stock Program options	75	127
Auditor's fees	76	128
Balance sheet	77	140
Profit and loss account	78	142
Fixed assets schedule	79	146
Shares in affiliated undertakings	80	146
Other external charges	81	148
Financial calendar	82	158

# INFORMATION RESOURCES

Further information including news, reports and publications can be found in the investor relations section of our website at [www.ir.stabilus.com](http://www.ir.stabilus.com).

## Investor Relations

Phone: +352 286 770 21

Fax: +352 286 770 99

Email: [investors@stabilus.com](mailto:investors@stabilus.com)



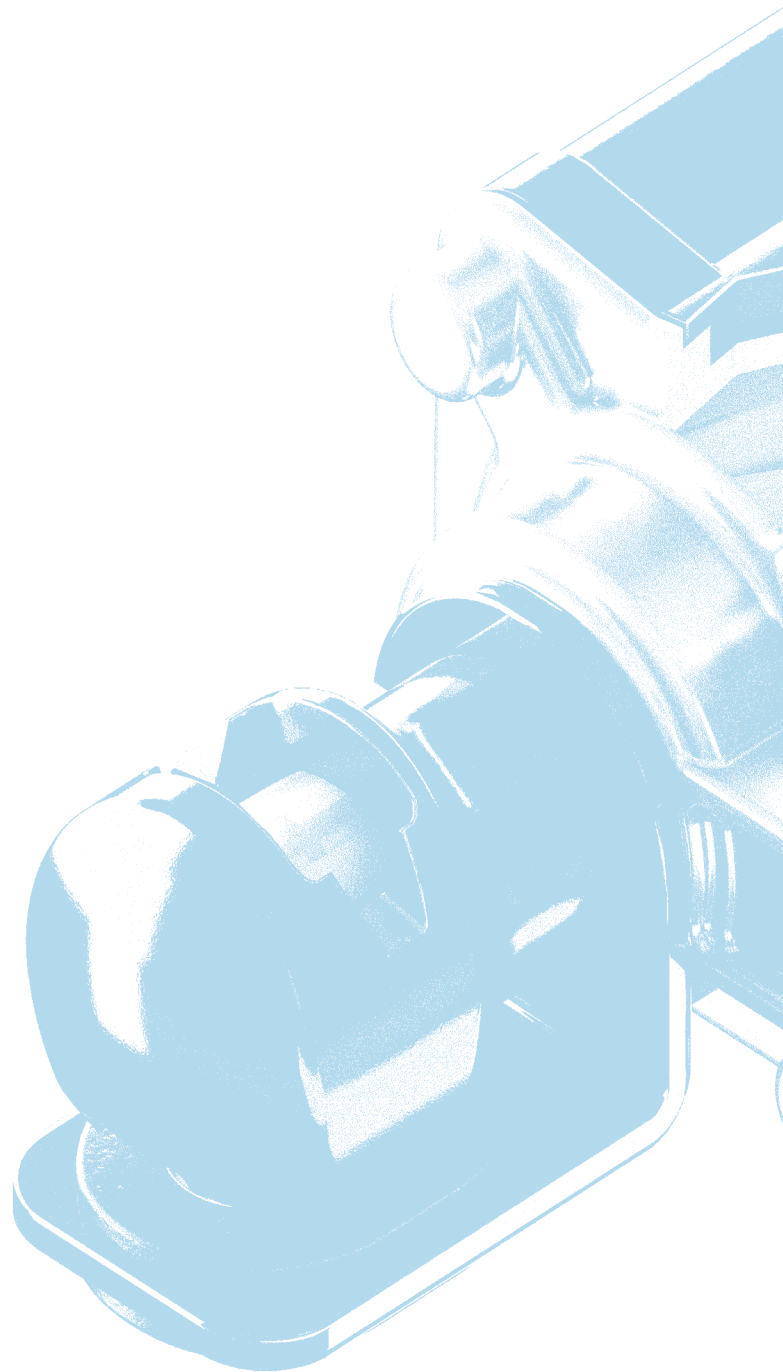

+ 2, rue Albert Borschette,  
L-1246 Luxembourg  
Grand Duchy of Luxembourg

[www.stabilus.com](http://www.stabilus.com)